



What We Do...

OUR SERVICES

Premium Quality

Custom Personalization

Sustainable Manufacturing

Exclusive Client Experience

DENTAL
INSTRUMENTS



About Us – MM Dental Corp

Precision in Every Instrument. Excellence in Every Detail

MM DENTAL CORP — Where Quality Meets Professional Excellence.

Founded in 2002 in Sialkot, Pakistan, MM Dental Corp carries forward three generations of expert craftsmanship in surgical and dental instrument manufacturing. Our passion for innovation, quality, and precision has made us a trusted name in the global dental industry.

- 🏆 35+ Years of Trusted Care
- 👨‍⚕️ Certified & Experienced Dentists
- ★ 5,000+ Happy Clients

250+

Expert Doctors

2k+

Recovered Patients

98%

Satisfied Rate





Incisors And Cuspids 1

MDC-51-001

Tooth Ext Forceps

Fig -1

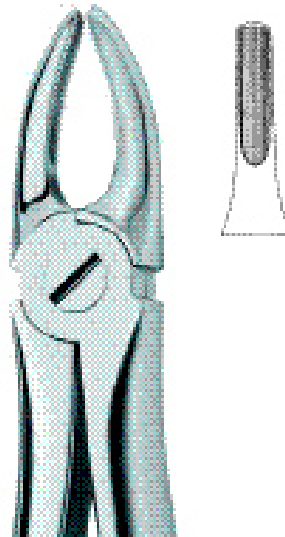

Incisors And Bicuspids 2

MDC-51-002

Tooth Ext Forceps

Fig -2



Lower Incisors And Canines 4

MDC-004

Tooth Ext Forceps

Fig -4

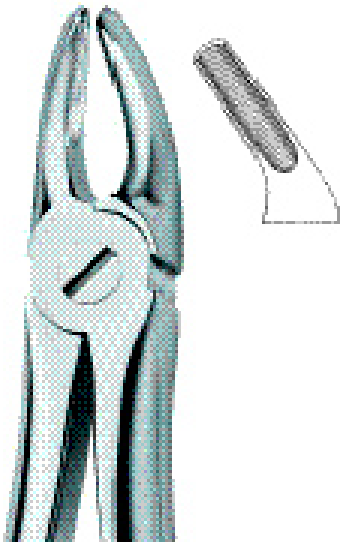

Bicuspids 7

MDC-51-007

Tooth Ext Forceps

Fig -7



Lower Bicuspids,Universal 13

MDC-51-013

Tooth Ext Forceps

Fig -13

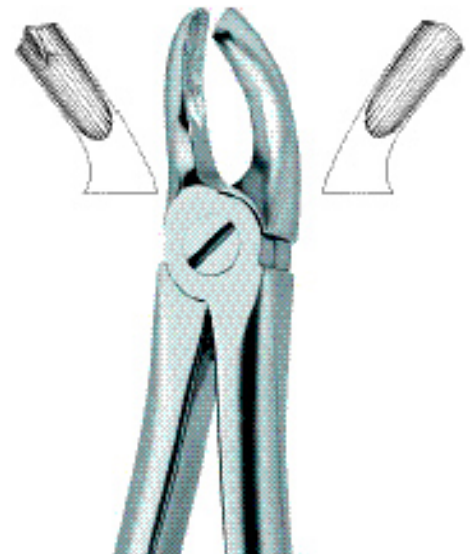

Molars,Right 17

MDC-51-017

Tooth Ext Forceps

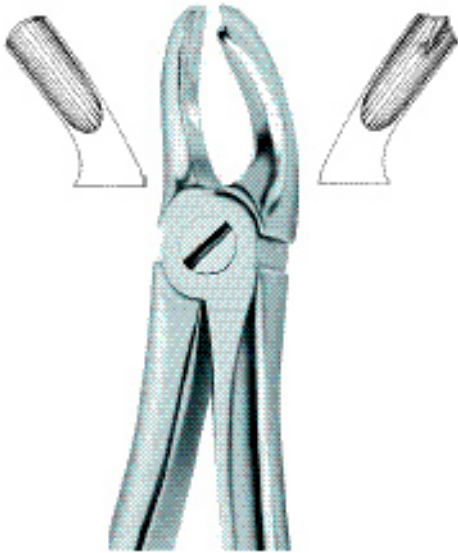

Molars, Left 18

MDC-51-018

Tooth Ext Forceps

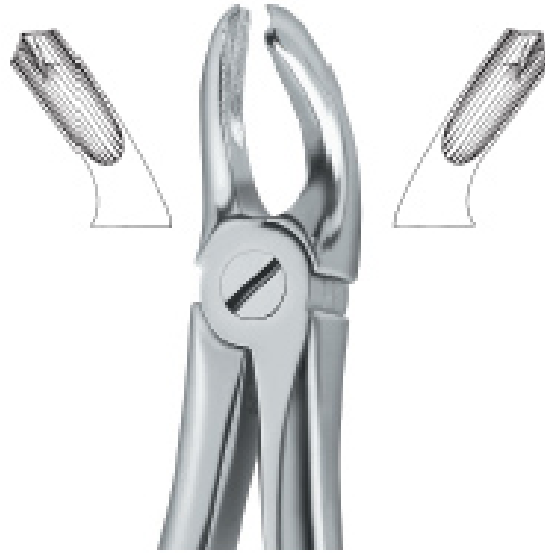

Molars 18A

MDC-51-018-01

Tooth Ext Forceps



Lower Molars, Universal 22

MDC-51-022

Tooth Ext Forceps

Fig -22



Lower Molars, Right 23

MDC-51-023

Tooth Ext Forceps

Fig -23



Lower Molars, Left 24

MDC-51-024

Tooth Ext Forceps



Upper Roots And Incisors 29

MDC-51-029

Tooth Ext Forceps



Lower Roots 33

MDC-51-033

Tooth Ext Forceps



Lower Roots 01

MDC-51-033-01

Tooth Ext Forceps



Lower Roots 03

MDC-51-033-03

Tooth Ext Forceps



Lower Roots 06

MDC-51-033-06

Tooth Ext Forceps



Incisors And Bicuspid 34N

MDC-51-034

Tooth Ext Forceps

Fig -34N



Incisors And Bicuspid 35N

MDC-51-035

Tooth Ext Forceps

Fig -35N



Tooth Ext Forceps

MDC-51-036

Tooth Ext Forceps



Lower Roots 46

MDC-51-046

Tooth Ext Forceps



Lower Roots 46

MDC-51-046-01

Tooth Ext Forceps



Lower Roots 46

MDC-51-046-02

Tooth Ext Forceps



Very Fine Roots 49

MDC-51-049

Tooth Ext Forceps



Roots 51

MDC-51-051

Tooth Ext Forceps



Roots 51A

MDC-51-051-01

Tooth Ext Forceps



Roots 51 C

MDC-51-051-03

Tooth Ext Forceps



Tooth Ext Forceps

MDC-51-057

Tooth Ext Forceps



Tooth Ext Forceps

MDC-51-057-1

Tooth Ext Forceps



Tooth Ext Forceps

MDC-51-057-02

Tooth Ext Forceps



Third Molars 67

MDC-51-067

Tooth Ext Forceps



Third Molars 67 A
MDC-51-067-01
 Tooth Ext Forceps

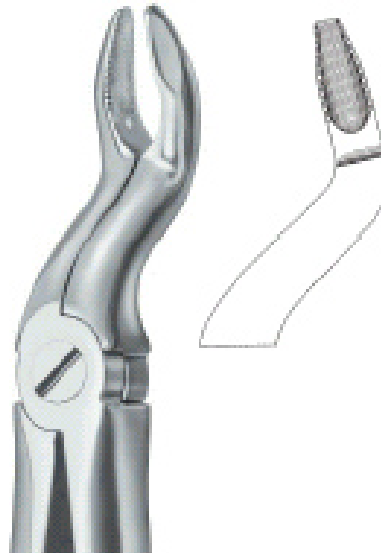

Third Molars Deep Griping 67 N
MDC-51-067-02
 Tooth Ext Forceps



Lower Molars 73
MDC-51-073
 Tooth Ext Forceps
 Fig -77



Lower Roots 74
MDC-51-074
 Tooth Ext Forceps



Incisors And Roots 74N
MDC-51-074-06
 Tooth Ext Forceps
 Fig -74N



Incisors And Roots ,Slender Jaw74XN
MDC-51-074-07
 Tooth Ext Forceps
 Fig -74XN



Incisors And Bicuspid

MDC-51-075

Tooth Ext Forceps

Fig -75



Upper Roots 76

MDC-51-076

Tooth Ext Forceps



Upper Roots 76N

MDC-51-076-07

Tooth Ext Forceps



Third Molars 79

MDC-51-079

Tooth Ext Forceps



Third Molars 79A

MDC-51-079-01

Tooth Ext Forceps

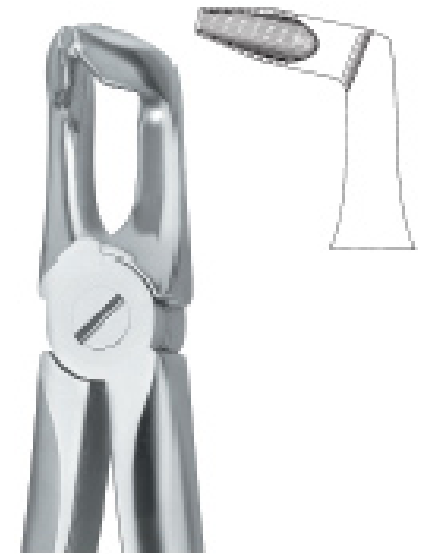

Third Molars ,Deep Gripping 79N

MDC-51-079-02

Tooth Ext Forceps



**Molars With Carious Or Broken Caps
86A**

MDC-51-086-01
Tooth Ext Forceps



**Molars With Carious Or Broken Caps
86B**

MDC-51-086-02
Tooth Ext Forceps



**Molars With Carious Or Broken Caps
86C**

MDC-51-086-03
Tooth Ext Forceps



Tooth Ext Forceps

MDC-51-097
Tooth Ext Forceps



Very Fine Roots 133

MDC-51-133
Tooth Ext Forceps



Roots Fragments, Deep Griping 146

MDC-51-146
Tooth Ext Forceps



Tooth Ext Forceps

MDC-51-151

Tooth Ext Forceps



Tooth Ext Forceps

MDC-51-153

Tooth Ext Forceps



Roots, With Parallel Beak 233

MDC-51-233

Tooth Ext Forceps



Incisors And Bicuspid 1

MDC-51-301

Tooth Ext Forceps

Fig -1

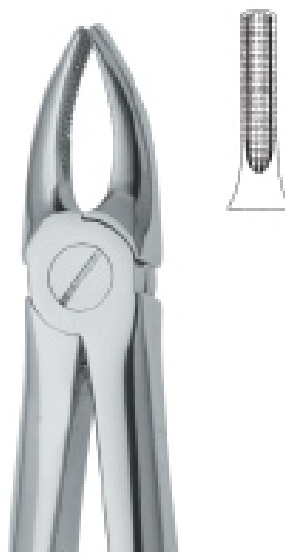

Incisors And Bicuspid 2

MDC-51-302

Tooth Ext Forceps

Fig -2



Bicuspid 7

MDC-51-307

Tooth Ext Forceps

Fig -7



Bicuspid 13
MDC-51-313
 Tooth Ext Forceps
 Fig -13

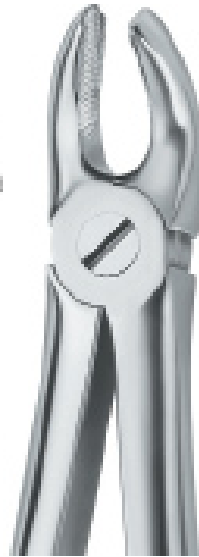
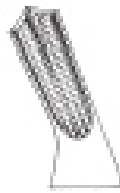

Molars 17
MDC-51-317
 Tooth Ext Forceps

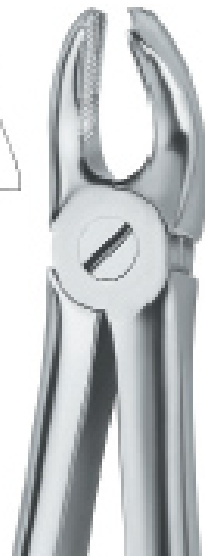
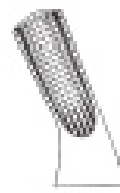

Molars 18
MDC-51-318
 Tooth Ext Forceps

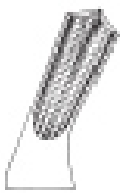

Molars 22
MDC-51-322
 Tooth Ext Forceps



Roots 33
MDC-51-330
 Tooth Ext Forceps



Roots 33
MDC-51-333
 Tooth Ext Forceps

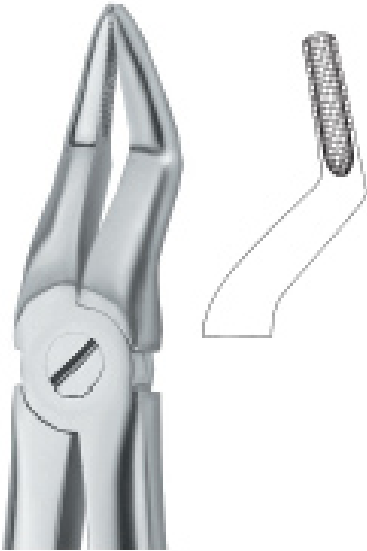

Roots 51
MDC-51-351
 Tooth Ext Forceps

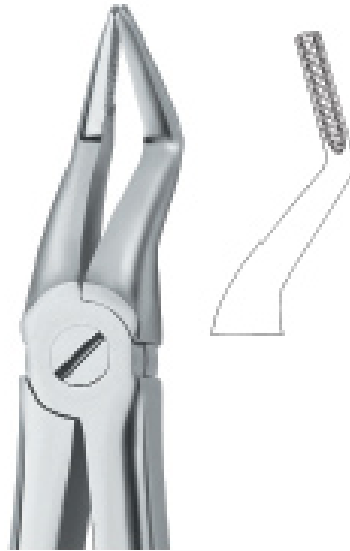

Roots, Very Fine Beak 51A
MDC-51-351-01
 Tooth Ext Forceps



Third Molars 67 A
MDC-51-367-01
 Tooth Ext Forceps



Molars 73
MDC-51-373
 Tooth Ext Forceps



Incisors And Roots 74
MDC-51-374
 Tooth Ext Forceps
 Fig -74



Incisors And Roots , With Fine Beak 74N
MDC-51-374-01
 Tooth Ext Forceps
 Fig -74N



Third Molars 79
MDC-51-379
Tooth Ext Forceps



Incisors And Cuspids 1
MDC-51-401
Tooth Ext Forceps
Fig -1



Bicuspids 7
MDC-51-407
Tooth Ext Forceps
Fig -7



Incisors And Cuspids 13
MDC-51-413
Tooth Ext Forceps
Fig -13

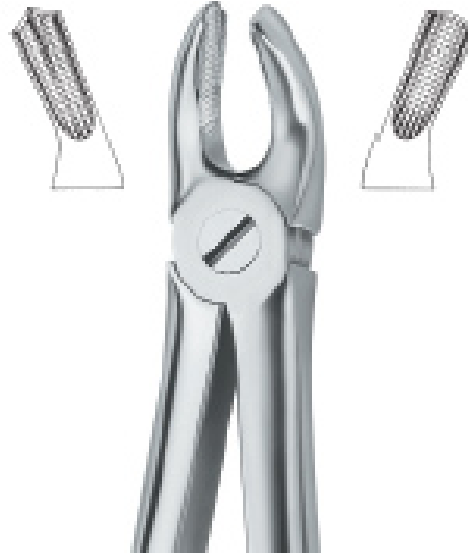

Molars , Right 17
MDC-51-417
Tooth Ext Forceps



Molars , Left 18
MDC-51-418
Tooth Ext Forceps



Molars 22

MDC-51-422

Tooth Ext Forceps



Roots 33

MDC-51-433

Tooth Ext Forceps



Very Fine Roots 46

MDC-51-446

Tooth Ext Forceps

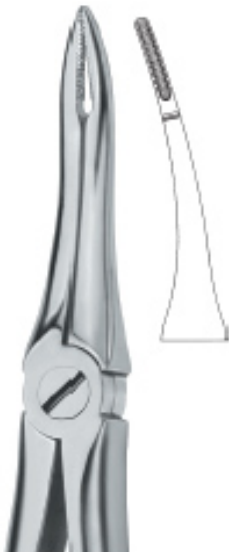

Very Fine Roots 49

MDC-51-449

Tooth Ext Forceps



Roots 51

MDC-51-451

Tooth Ext Forceps



Roots , With Fine Beak 51A

MDC-51-451-01

Tooth Ext Forceps



Martin Ergo 67A
MDC-51-467-01
 Tooth Ext Forceps



Martin Ergo 74N
MDC-51-474
 Tooth Ext Forceps



Martin Ergo 79
MDC-51-479
 Tooth Ext Forceps



Martin Ergo ,Very Fine Roots 97
MDC-51-497



Bicuspid 13S
MDC-51-613-09
 Tooth Ext Forceps
 Fig -13s



Molars 22s
MDC-51-622-09
 Tooth Ext Forceps



Incisors And Roots 30S

MDC-51-630-09
Tooth Ext Forceps
Fig -30S



Roots 33S

MDC-51-633-09
Tooth Ext Forceps



Incisors And Bicuspid 37

MDC-51-637
Tooth Ext Forceps
Fig -37



Incisors And Cuspids 38

MDC-51-638
Tooth Ext Forceps
Fig -38



Molars 39

MDC-51-639
Tooth Ext Forceps



Molars 39A

MDC-51-639-01
Tooth Ext Forceps



Molars , Left 39L

MDC-51-639-05

Tooth Ext Forceps



Molars , Right 39R

MDC-51-639-08

Tooth Ext Forceps



Molars 40

MDC-51-640

Tooth Ext Forceps



Roots 51S

MDC-51-651-09

Tooth Ext Forceps



Roots 76S

MDC-51-676-09

Tooth Ext Forceps



Molars 3

MDC-51-703

Tooth Ext Forceps



Incisors 5

MDC-51-705

Tooth Ext Forceps

Fig -5



Molars 6

MDC-51-706

Tooth Ext Forceps



Roots 7

MDC-51-707

Tooth Ext Forceps



Incisors And Cuspids 137

MDC-51-737

Tooth Ext Forceps

Fig -137



Bicuspid 139

MDC-51-739

Tooth Ext Forceps

Fig -139



Klein , Roots 51S

MDC-51-751-09

Tooth Ext Forceps

Fig -51S



Molars 17SK

MDC-51-817-09

Tooth Ext Forceps



Molars 23SK

MDC-51-823-09

Tooth Ext Forceps



Teeth And Roots ,Universal 150SK

MDC-51-850-09

Tooth Ext Forceps



Teeth And Roots ,Universal 151Sk

MDC-51-851-09

Tooth Ext Forceps



Incisors And Bicuspidis 1

MDC-52-001

Tooth Ext Forceps Amr

18.5cm



Henahan Incisors

MDC-52-001-01

Tooth Ext Forceps Amr



Molars And Third Molars 10S

MDC-52-010-09

Tooth Ext Forceps Amr

Fig -10s



Molars 15

MDC-52-015

Tooth Ext Forceps Amr



Molars 16

MDC-52-016

Tooth Ext Forceps Amr

Fig -16



Molars , Slender Jaw

MDC-52-016-09

Tooth Ext Forceps Amr

Fig -16



Molars 17

MDC-52-017

Tooth Ext Forceps Amr

Fig -17

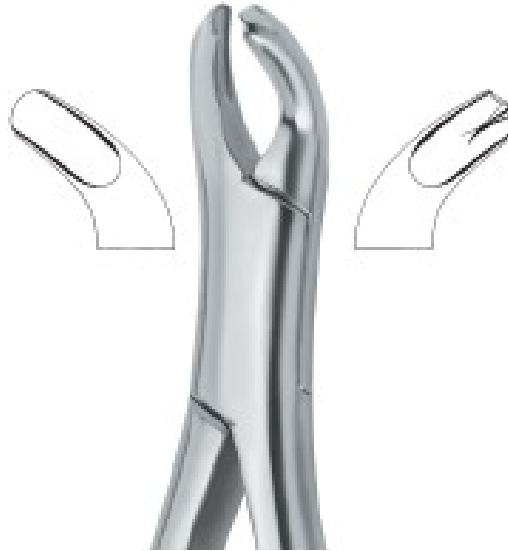

Harris Molars , Left 18L

MDC-52-018-05

Tooth Ext Forceps Amr

Fig -18L

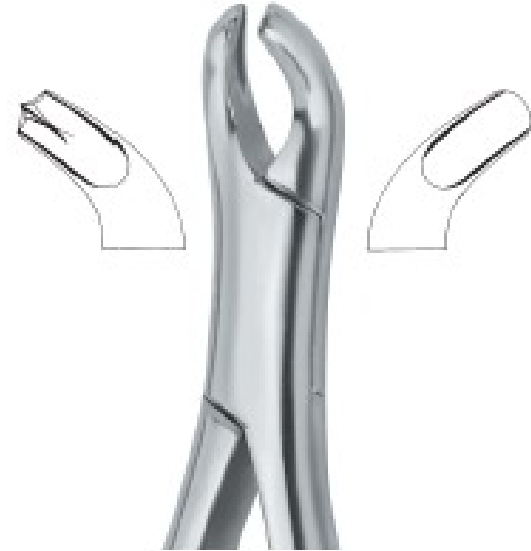

Harris Molars , Right 18R

MDC-52-018-08

Tooth Ext Forceps Amr

Fig -18R



Molars

MDC-52-023

Tooth Ext Forceps Amr

Fig -23



Parmlly Molars And Bicuspid 32

MDC-52-032

Tooth Ext Forceps Amr

Fig -32



Parmlly Molars And Bicuspid , Roots 32A

MDC-52-032-01

Tooth Ext Forceps Amr

Fig -32L



Molars , Left 53L

MDC-52-053-05

Tooth Ext Forceps Amr
18.5cm



Molars , Right 53R

MDC-52-053-08

Tooth Ext Forceps Amr
Fig -53R



Teeth And Roots, Universal Also For Children 62

MDC-

Tooth Ext Forceps Amr
Fig -62



Incisors And Roots 65

MDC-52-065

Tooth Ext Forceps Amr
Fig -65



Tomes Roots Fragments And Small Roots 69

MDC-52-069

Tooth Ext Forceps Amr



Nevius Molars , Left 88L

MDC-52-088-05

Tooth Ext Forceps Amr
Fig -88L



Nevius Molars , Right 88R

MDC-52-088-08

Tooth Ext Forceps Amr

Fig -88R



**Cryer Bicuspid, Incisors And
Roots 150**

MDC-52-150

Tooth Ext Forceps Amr



**Cryer Bicuspid, Incisors And
Roots 150A**

MDC-52-150-01

Tooth Ext Forceps Amr

Fig -150A



Bicuspid And Incisors , Roots 150X

MDC-52-150-02

Tooth Ext Forceps Amr

Fig -150X



**Bicuspid And Incisors, Roots
150AS**

MDC-52-150-08

Tooth Ext Forceps Amr

fig -150 A



**Cryer Bicuspid And Incisors ,
Roots 150S**

MDC-52-150-09

Tooth Ext Forceps Amr

Fig -150S



**Cryer Bicuspid , Incisors And Roots
151**

MDC-52-151

Tooth Ext Forceps Amr

Fig -151



**Cryer Bicuspid , Incisors And Roots
151A**

MDC-52-151-01

Tooth Ext Forceps Amr

Fig -151A



**Cryer Bicuspid , Incisors And Roots
151X**

MDC-52-151-02

Tooth Ext Forceps Amr

Fig 151X



Bicuspid And Incisors , Roots 151AS

MDC-52-151-08

Tooth Ext Forceps Amr

Fig -151 AS



**Cryer Teeth And Roots , Universal
151S**

MDC-52-151-09

Tooth Ext Forceps Amr

Fig -151S



Third Molars 222

MDC-52-222

Tooth Ext Forceps Amr

Fig -222



Root Fragments And Universal 501

MDC-52-501

Tooth Ext Forceps Amr

Fig -502



Witzel Root Fragments And Universal 502

MDC-52-502

Tooth Ext Forceps Amr

Root Elevators



Seldin 1L

MDC-53-001-05

Root Elevators



Seldin 1R

MDC-53-001-08

Root Elevator

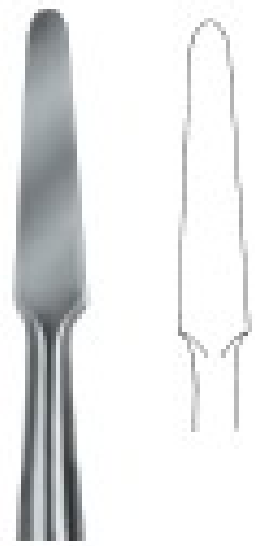

Seldin 2

MDC-53-002-00

Root Elevators

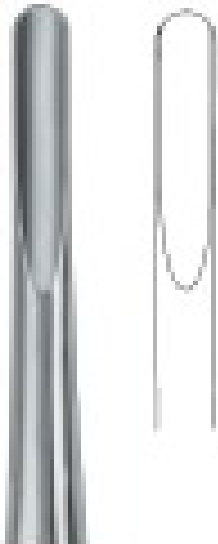

Seldin

MDC-53-003-00

Root Elevators

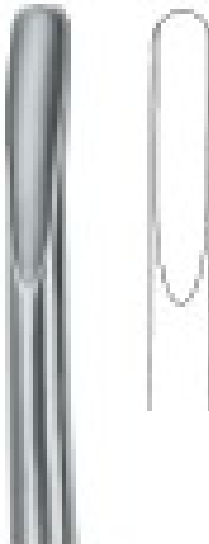

Cryer

MDC-53-003-01

Root Elevators



Seldin 4L

MDC-53-004-05

Root Elevators

Root Elevators



Seldin 4R
MDC-53-004-08
Root Elevators



Crane Pick 6
MDC-53-006-00
Root Elevators



Miller 1
MDC-53-008-00
Root Elevators

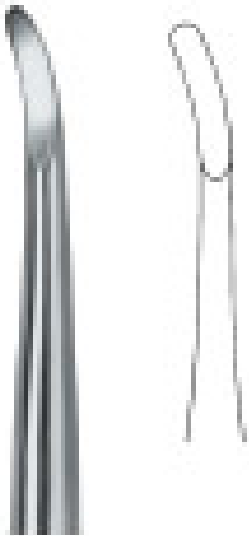

Miller 2
MDC-53-009-00
Root Elevators



Miller-Apexo
MDC-53-010-00
Root Elevators



Miller-Apexo
MDC-53-011-00
Root Elevators

Root Elevators



Cryer

MDC-53-012-00

Root Elevators



Cryer

MDC-53-027-00

Root Elevators



Cryer 28

MDC-028-00

Root Elevators



Seldin 34

MDC-53-034-00

Root Elevators

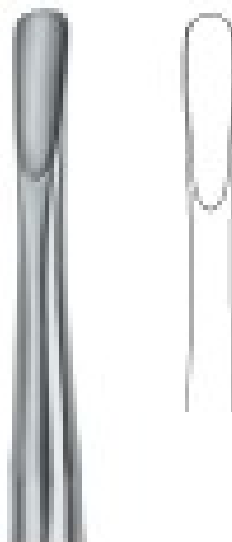

Seldin 34S

MDC-53-034-09

Root Elevators



Cryer 27S

MDC-53-039-00

Root Elevators

Root Elevators



Cryer 28S

MDC-53-040-00

Root Elevators

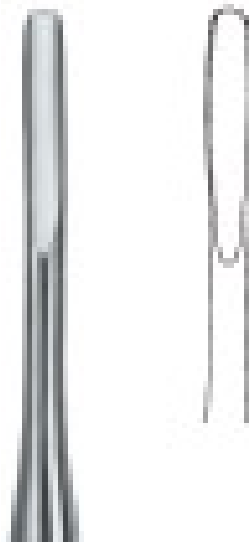

Flohr

MDC-53-046-00

Root Elevators



Barry 50

MDC-53-050-00

Root Elevators

Fig -50



Barry 51

MDC-53-051-00

Root Elevators

Fig -51



Lindo Levian 1

MDC-53-200-01

Root Elevators



Lindo Levian 3

MDC-53-200-03

Root Elevators



Howard-Apexo # 1
MDC-53-204-00
Root Elevators

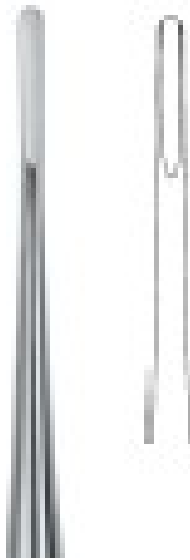

Root Elevators
MDC-53-204-01
Root Elevators

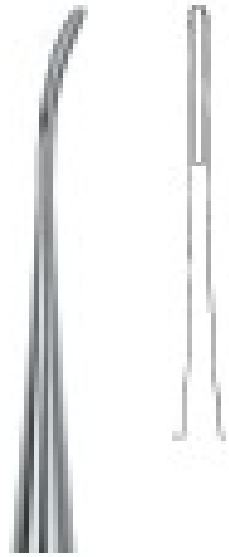

Root Elevators
MDC-53-205-00

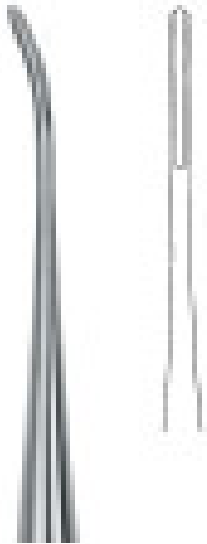

Root Elevators
MDC-53-205-01
Root Elevators



Bein 1
MDC-53-220-01
Root Elevator
Fig -1

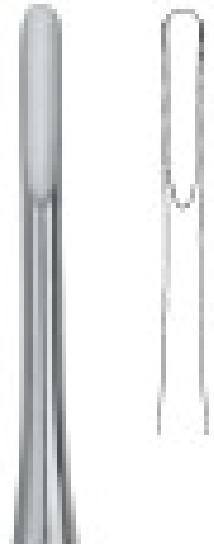

Bein 2
MDC-53-220-02
Root Elevator

Root Elevators

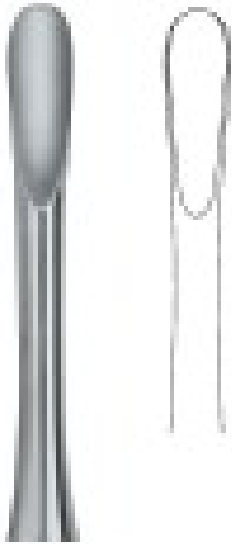

Bein 4
MDC-53-220-04

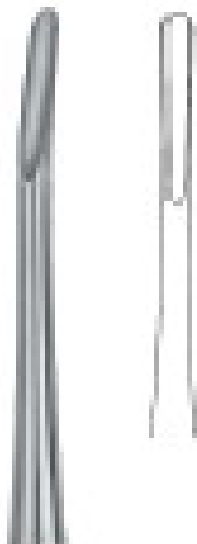

Bein 1A
MDC-53-221-01



Bein 2A
MDC-53-221-02

Fig -1A

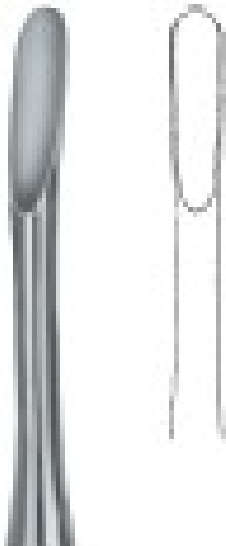

Bein 3A
MDC-53-221-03

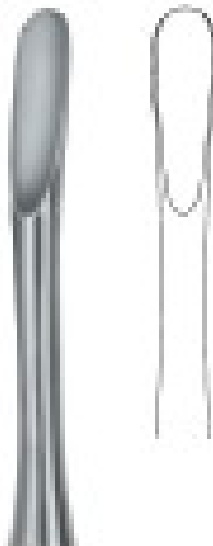

Bein 4A
MDC-53-221-04



Apical 1
MDC-53-222-01

Fig -1

Root Elevators

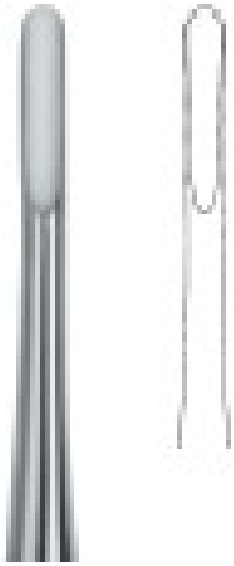

Apical 2
MDC-53-222-02

Fig -2

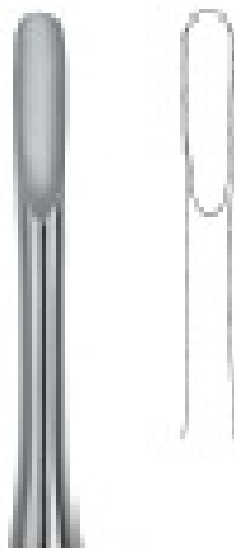

Apical 3
MDC-53-222-03

Fig -3



Apical 4
MDC-53-222-04

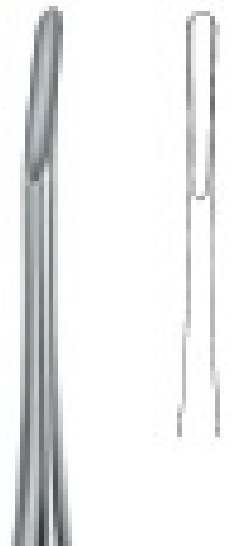

Apical 1A
MDC-53-223-01

Fig -1A

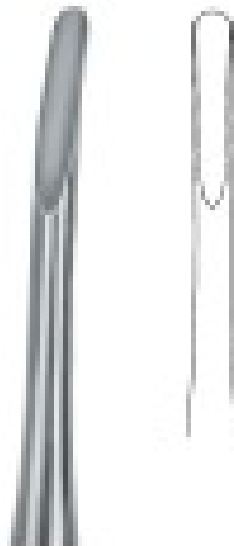

Apical 2A
MDC-53-223-02

Fig -2



Apical 3A
MDC-53-223-03

Root Elevators



Apical 4A
MDC-53-223-04

Fig -4A



Apical 301
MDC-53-301-00

Fig -301

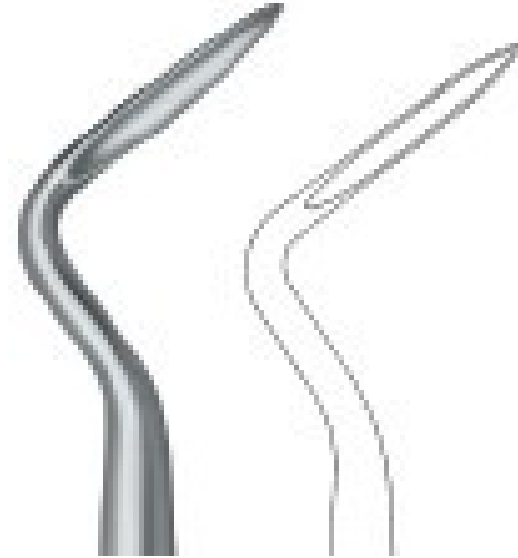

Apical 302
MDC-53-302-00
Root Elevators



Apical-Flohr
MDC-53-303-00
Root Elevators
Fig -303

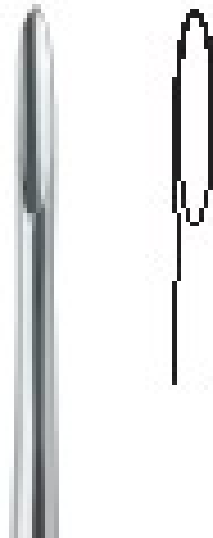

Apical 304
MDC-53-304-00
Root Elevators

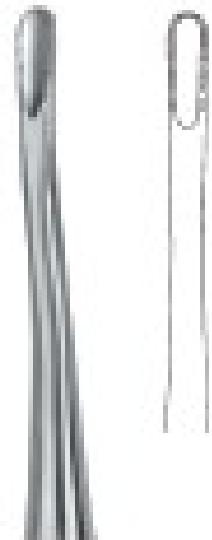

Apical 46R
MDC-53-311-00
Root Elevators

Root Elevators



Coleman
MDC-53-405-01
Root Elevators



Coleman 2L
MDC-53-405-02
Root Elevators



Coleman 3R
MDC-53-405-03
Root Elevators

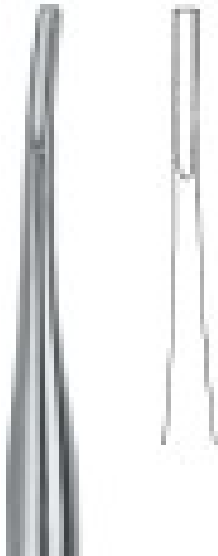

Coupland Bone Chisels 1
MDC-53-415-01
Root Elevators

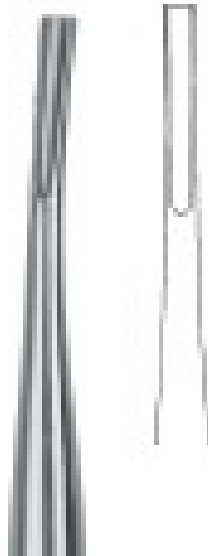

Coupland Bone Chisels 2
MDC-53-415-02
Root Elevators

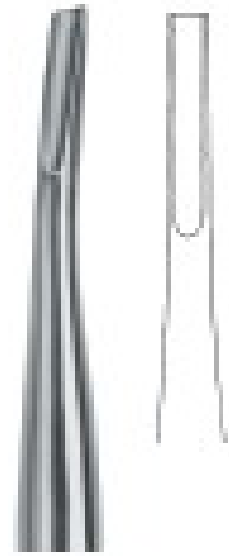

Coupland Bone Chisels 3
MDC-53-415-03
Root Elevators

Root Elevators



Friedman 1
MDC-53-505-01
Root Elevators



Friedman 2L
MDC-53-505-02
Root Elevators



Friedman 2R
MDC-53-505-03
Root Elevators



Hyllin 1
MDC-53-508-01
Root Elevators

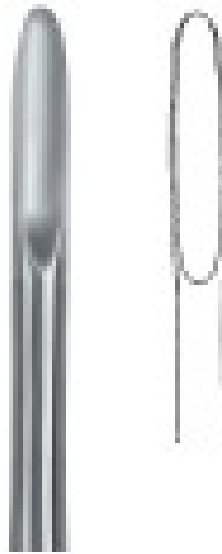

Hyllin 2
MDC-53-508-02
Root Elevators



Hyllin 3L
MDC-53-508-03
Root Elevators

Root Elevators

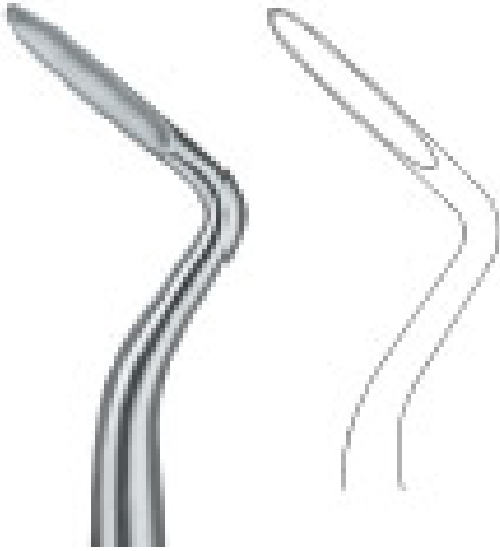

Hyllin 4R
MDC-53-508-04
Root Elevators



Bein 0
MDC-53-511-00
Root Elevators
Fig -0

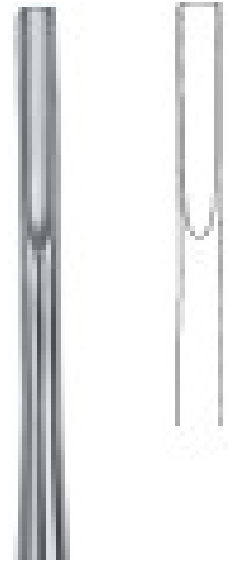

Bein 1
MDC-53-511-01
Root Elevators
Fig -1

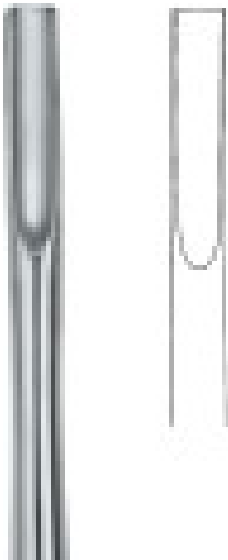

Bein 2
MDC-53-511-02
Root Elevators
Fig -2

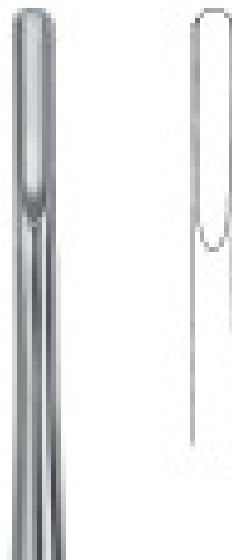

Bein 1
MDC-53-512-01
Root Elevators
Fig -1

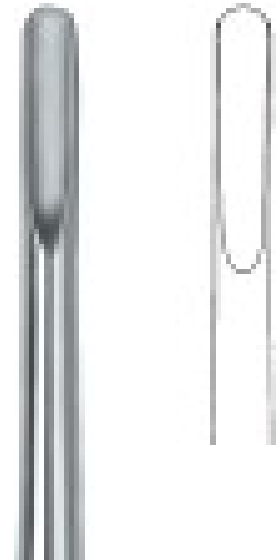

Bein 2
MDC-53-512-02
Root Elevators

Root Elevators



Bein 0

MDC-53-513-00

Root Elevators

Fig -0

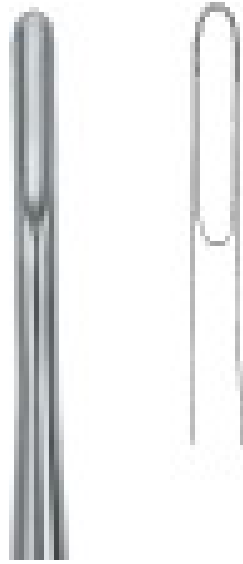

Bein 1

MDC-53-513-01

Root Elevators

Fig -1

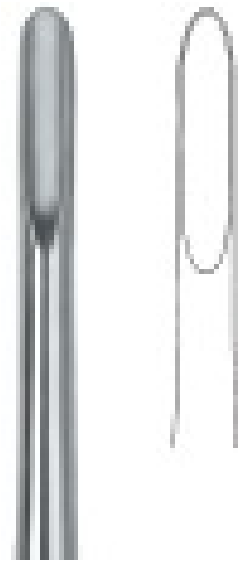

Bein 2

MDC-53-513-02

Root Elevators



Bein 0A

MDC-53-514-00

Root Elevators

Fig -0A

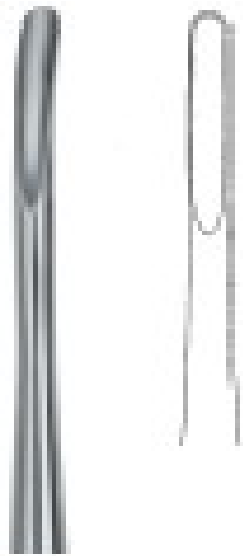

Bein 1A

MDC-53-514-01

Root Elevators

Fig -1A

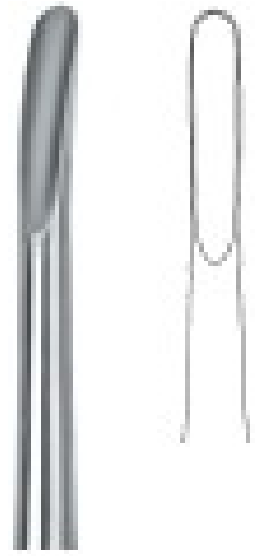

Bein 2A

MDC-53-514-02

Root Elevators

Root Elevators



Bein 0A

MDC-53-515-00

Root Elevators

Fig -0A

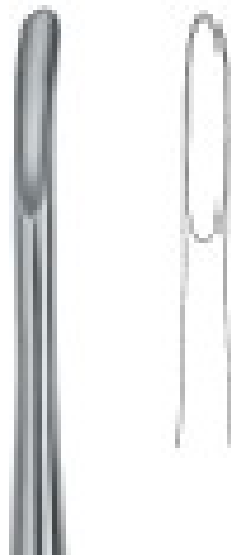

Bein 1A

MDC-53-515-01

Root Elevators

Fig -1A

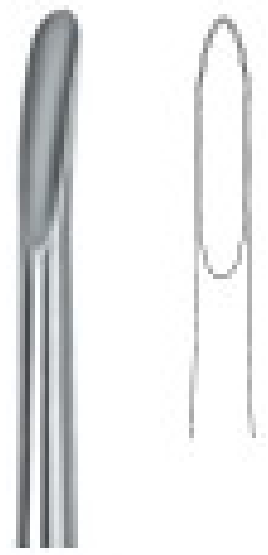

Bein 2A

MDC-53-515-02

Root Elevators



W.F. Barry 320L

MDC-53-533-20

Root Elevators



W.F. Barry 321R

MDC-53-533-21

Root Elevators



Barry 322

MDC-53-533-22

Root Elevators

Fig -322

Root Elevators



Barry 323

MDC-53-533-23

Root Elevators

Fig -323



W.F. Barry 370R

MDC-53-533-70

Root Elevators



W.F. Barry 371R

MDC-53-533-71

Root Elevators



Winter 11L

MDC-53-551-05

Root Elevators



Winter 11R

MDC-53-551-08

Root Elevators



Winter 13L

MDC-53-553-05

Root Elevators

Root Elevators



Winter 13R

MDC-53-553-08

Root Elevators



Winter 14L

MDC-53-554-05

Root Elevators



Winter 14R

MDC-53-554-08

Root Elevators



Lecluse 1

MDC-53-561-01

Root Elevators



Pott 1

MDC-53-567-01

Root Elevators



Pott 2

MDC-53-567-02

Root Elevators

Root Elevators



Krallenheber 1L
MDC-53-571-01
Root Elevators



Krallenheber 2R
MDC-53-571-02
Root Elevators



Warwick-James 1
MDC-53-576-01
Root Elevators

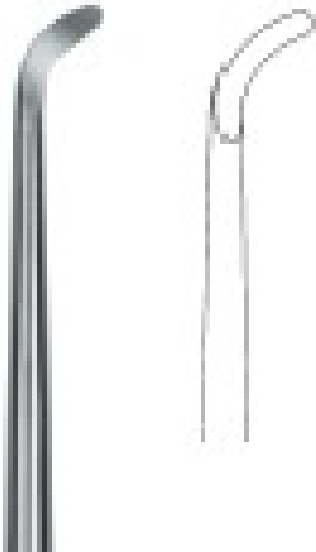

Warwick-James 2L
MDC-53-576-02
Root Elevators



Warwick-James 3R
MDC-53-576-03
Root Elevators

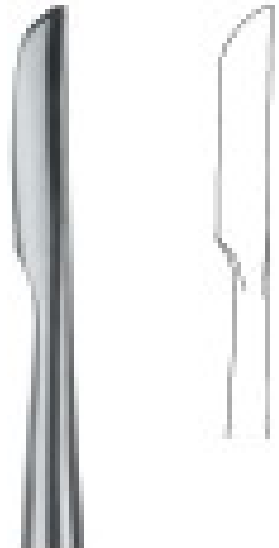

Chompret 1
MDC-53-577-01
Root Elevators

Root Elevators



Chompret 2

MDC-53-577-02

Root Elevators



Chompret 3

MDC-53-577-03

Root Elevators



Heidebrink 1

MDC-53-582-01

Root Elevators



Heidebrink 2

MDC-53-582-02

Root Elevators



Heidebrink 3

MDC-53-582-03

Root Elevators



West 1

MDC-53-584-01

Root Elevators

Root Elevators

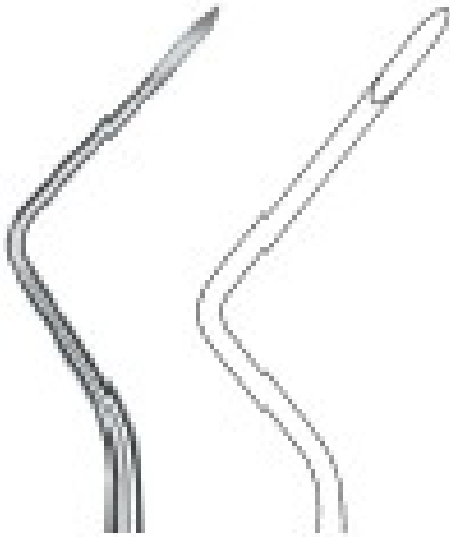

West 2

MDC-53-584-02

Root Elevators

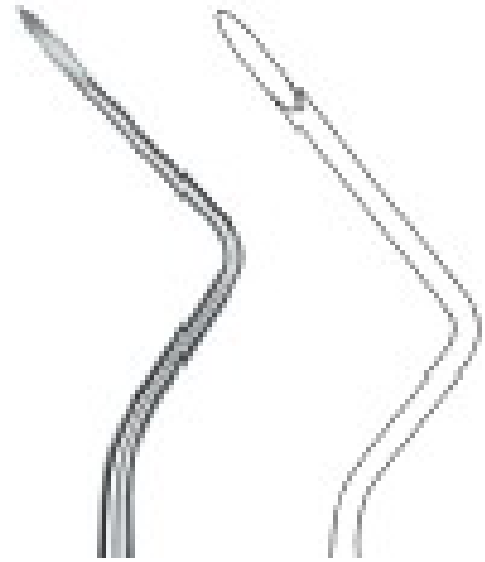

West 3

MDC-53-584-03

Root Elevators

Bone Rongeurs



Bone Rongeur

MDC-54-101

Bone Holding Forceps
7"185mm



Bone Rongeur

MDC-54-102

Bone Holding Forceps
7"185mm



Bone Rongeur

MDC-54-103

Bone Holding Forceps
8"200mm



Bone Rongeur

MDC-54-104

Bone Holding Forceps
8"215mm



Bone Rongeur

MDC-54-105

Bone Rongeur
145mm5"



Friedman-Micro 6"

MDC-54-106

Bone Rongeurs
5"150mm

Bone Rongeurs



Friedman-Micro 5"

MDC-54-107

Bone Rongeurs
145mm5"



Bone Rongeur

MDC-54-108

Bone Rongeur
5"140mm



LUER 6"

MDC-54-109

Bone Rongeurs
150mm6"



LUER 6"

MDC-54-110

Bone Rongeurs
150mm6"



2A-MEAD, SQUARE TIPS 5"

MDC-54-111

Bone Rongeur
145mm5"



BLUMENTHAL 6"

MDC-54-112

Bone Rongeur
6"155mm

Bone Rongeurs



BLUMENTHAL 45 6"

MDC-54-113
Bone Rongeur
150mm 6"



Bone Rongeur 7"

MDC-54-114
Bone Rongeur
7" 175mm



Bone Rongeur

MDC-54-115
Bone Rongeur
5" 170mm



BEYER 7"

MDC-54-116
Bone Rongeur
7" 180mm



BANE-HEARTMANN 7"

MDC-54-118
Bone Rongeur
175mm 7"



BEYER DOUBLE-ACTION 7"

MDC-54-119
Bone Rongeur
7" 180mm

Bone Rongeurs



ZUFAL-JANSEN 7"

MDC-54-120

Bone Rongeur

7"180mm



Bone Rongeur

MDC-54-121

Bone Rongeur

130mm5.5"



Bone Rongeur

MDC-54-122

Bone Rongeur

130mm5.5"



Cleveland 5"

MDC-54-123

Bone Cutting Forceps

5"130mm



Bone Rongeur

MDC-54-124

Bone Cutting Forceps

5"160mm

Bone Files



Fig. 1
Polokoff

Polokoff
MDC-55-101
Bone Files
Fig -1



Fig. 33

Bone Files
MDC-55-102
Bone Files
Fig -33

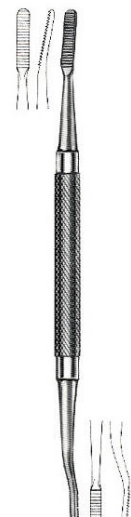

Fig. 64
Miller

Miller
MDC-55-103
Bone Files
Fig -64



Fig. 45
Miller

Miller
MDC-55-104
Bone Files
Fig -45



Fig. 10

Bone Files
MDC-55-105
Bone Files
Fig -10



Fig. 1
Wahl

Wahl
MDC-55-106
Bone Files
Fig -1

Bone Files



Fig. 2
Wahl

Wahl
MDC-55-107
Bone Files
Fig -2

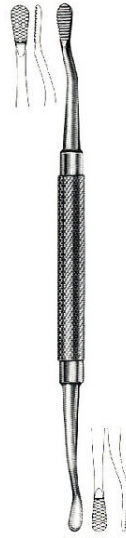

Fig. 12CA

Bone Files
MDC-55-108
Bone Files
Fig -12CA

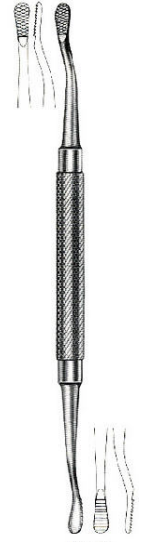

Fig. 12A

Bone Files
MDC-55-109
Bone Files
Fig -12A

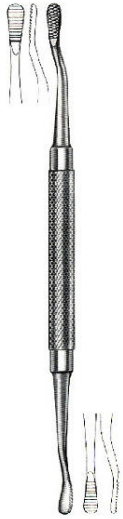

Fig. 12
Howard

Howard
MDC-55-110
Bone Files
Fig -12

Bone Currettes



Fig 1
Hemingway

Hemingway

MDC-56-101

Bone Currettes

Fig -1



Fig 2
Hemingway

Hemingway

MDC-56-102

Hemingway

Fig -2



Fig 3
Hemingway

Hemingway

MDC-56-103

Bone Currettes

Fig -3



Fig 4
Hemingway

Hemingway

MDC-56-104

Bone Currettes

Fig -4



Fig. 86
Lucas

Lucas

MDC-56-105

Bone Currettes

Fig -86



Fig. 87
Lucas

Lucas

MDC-56-107

Bone Currettes

Fig -87

Bone Curettes



Fig. 88
Lucas

Lucas

MDC-56-108

Bone Curettes

Fig -88



Fig. 1
Hemingway

Hemingway

MDC-56-109

Bone Curettes

Fig -1



Fig. 2
Hemingway

Hemingway

MDC-56-110

Bone Curettes

Fig -2



Fig. 3
Hemingway

Hemingway

MDC-56-111

Bone Curettes



Fig. 4
Hemingway

Hemingway

MDC-56-112

Bone Curettes

Fig -4



Fig. 85
Lucas

Lucas

MDC-56-113

Bone Curettes

Fig -85

Bone Curettes



Fig. 86
Lucas

Lucas

MDC-56-114

Bone Curettes

Fig -86



Fig. 87
Lucas

Lucas

MDC-56-115

Bone Curettes

Fig -87



Fig. 83
Lucas

Lucas

MDC-56-116

Bone Curettes

Fig -83



Cotton & Dressing Tweezers

MDC-57-101

Tooth Tweezers

5"130mm



College Tweezer

MDC-57-102

Cotton & Dressing Tweezers

5"130mm



College Tweezer Smooth Plan Handle

MDC-57-103

Cotton & Dressing Tweezers

150mm6"



Meriam Tweezers

MDC-57-104

Cotton & Dressing Tweezers

6"160mm



College Tweezer

MDC-57-105

Cotton & Dressing Tweezers

6"160mm



Meriam Tweezers

MDC-57-106

Cotton & Dressing Tweezers

6"160mm



Meriam Tweezers

MDC-57-107

Cotton & Dressing Tweezers
6"160mm



College Tweezer

MDC-57-108

Cotton & Dressing Tweezers
150mm6"



College Tweezer

MDC-57-109

Cotton & Dressing Tweezers
150mm6"



Self Locking Tweezer Serr.

MDC-57-110

Cotton & Dressing Tweezers
6"160mm



College Tweezer

MDC-57-111

Cotton & Dressing Tweezers
6"160mm



College Tweezer

MDC-57-112

Cotton & Dressing Tweezers
150mm6"



Perry Tweezer

MDC-57-113

Cotton & Dressing Tweezers
130mm



Cotton & Dressing Tweezers

MDC-57-114

Cotton & Dressing Tweezers
6"160mm



Flagg Tweezer Smooth

MDC-57-115

Cotton & Dressing Tweezers
150mm6"



Flagg Tweezer Serrated

MDC-57-116

Cotton & Dressing Tweezers
5"160mm



Cotton & Dressing Tweezers

MDC-57-117

Cotton & Dressing Tweezers
5"150mm



Cotton & Dressing Tweezers

MDC-57-118

Tooth Tweezers
6"160mm



Cotton & Dressing Tweezers

MDC-57-119

Tooth Tweezers

6"160mm



Self Locking Tweezer Smooth

MDC-57-120

Cotton & Dressing Tweezers

150mm6"



Suture Forceps

MDC-57-121

Cotton & Dressing Tweezers

150mm6"



Rubber Dam Punch Ivory

MDC-58-101

Rubber-Dam Instruments

6"160mm



Anisworth

MDC-58-102

Rubber-Dam Instruments

6"160mm



Brewer

MDC-58-103

Rubber-Dam Instruments

6"170mm



Palmer

MDC-58-104

Rubber-Dam Instruments

7"175mm



Crile-Murray
MDC-60-101
Needle Holders
5"130mm



Mayo-Hegar
MDC-60-102
Needle Holders
7"160mm



Crile-Murray
MDC-60-103
Needle Holders
150mm6"



Mayo-Hegar
MDC-60-104
Needle Holders
150mm6"



Mayo-Hegar
MDC-60-105
Needle Holders
7"180mm



Mayo-Hegar
MDC-60-106
Needle Holders
8"200mm

Needle Holders

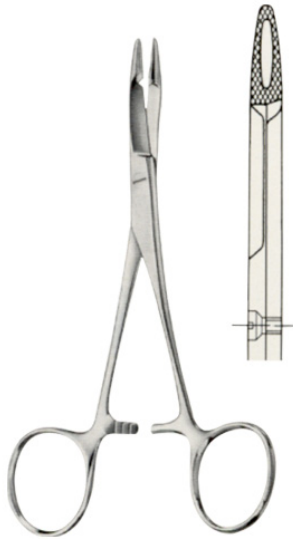

Olsen-Hegar
MDC-60-107
 Needle Holders
 5"140mm



Gillies
MDC-60-108
 Needle Holders
 7"150mm



Boynton
MDC-60-109
 Needle Holders
 5"125 mm



Mathieu
MDC-60-110
 Needle Holders
 7"170mm



Mathieu
MDC-60-111
 Needle Holders
 8"200mm



Crile
MDC-60-112
 Needle Holders
 150mm6"



Toennis
MDC-60-113
Needle Holders



Mayo-Hegar
MDC-60-114
Needle Holders
7"165mm



Mayo-Hegar
MDC-60-115
Needle Holders
8"210mm

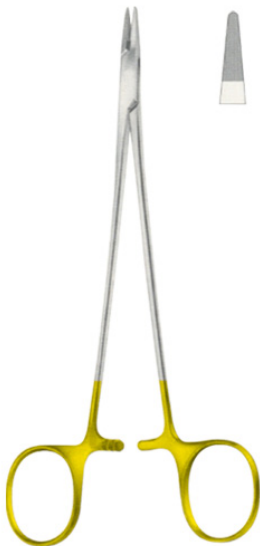

Mayo-Hegar
MDC-60-116
Needle Holders
165mm



Mayo-Hegar
MDC-60-117
Needle Holders
6"165mm



Debakey
MDC-60-118
Needle Holders
5"160mm



Debakey

MDC-60-119

Needle Holders

7"



Ryder

MDC-60-120

Needle Holders



Ryder

MDC-75-121

Needle Holders



Ryder 7 CARB-N-SERT Jaws

MDC-60-122

Needle Holders



Bozemann 5

MDC-60-123

Needle Holders

5"135mm



Olsen-Hegar CARB-N-SERT Jaws

MDC-60-124

Needle Holders



Olsen-Hegar CARB-N-SERT Jaws

MDC-60-125
Needle Holders



Olsen-Hegar CARB-N-SERT Jaws

MDC-60-126
Needle Holders



Olsen-Hegar CARB-N-SERT Jaws

MDC-60-127
Needle Holders



Needle Holders

MDC-60-128
Needle Holders
7"185mm



Needle Holders

MDC-60-129
Needle Holders
7"185mm



Ryder 8 CARB-N-SERT Jaws

MDC-60-130
Needle Holders



Needle Holders

MDC-60-131

Needle Holders
8"200mm



Mathieu 5

MDC-60-132

Needle Holders
5"140mm



Mathieu 6

MDC-60-133

Needle Holders
5"170mm



Mathieu 8

MDC-60-134

Needle Holders
8"200mm



Mathieu 5

MDC-60-135

Needle Holders
5"140mm



Mathieu 6

MDC-60-136

Needle Holders
6"170mm



Mathieu 8
MDC-60-137
Needle Holders
8"200mm



Mathieu 7
MDC-60-138
Needle Holders
7"195mm



Mathieu CARB-N-SERT Jaws
MDC-60-139
Needle Holders
8"205mm



LISTER Bandage Scissors

MDC-61-101
GUM Scissors
Extra fine



LISTER Bandage Scissors

MDC-61-102
Gum Scissors
Extra fine



LISTER Bandage Scissors

MDC-61-103
Gum Scissors
Extra fine



KNOWLES Bandage Scissors

MDC-61-104
Gum Scissors
Straight



HEATH Suture Scissors

MDC-61-105
Gum Scissors Serrated blade
6-1/8" (15.6cm)



SPENCER Stitch Scissors

MDC-61-106
Gum Scissors
Delicate

Gum Scissors



SHORTBENT Stitch Scissors

MDC-61-107

Gum Scissors Curved delicate



LITTAUER JR. Stitch Scissors

MDC-61-108

Gum Scissors



NORTHBENT Stitch Scissors

MDC-61-109

Gum Scissors Curved light pattern



LITTAUER Stitch Scissors

MDC-61-110

Gum Scissors Standard pattern



LONG Oral Surgery Stitch Scissors

MDC-61-111

Gum Scissors



MILTEX Stitch Scissors

MDC-61-112

Gum Scissors Angled delicate

Gum Scissors



REEH Stitch Scissors

MDC-61-113

Gum Scissors

Sharp tips small hook on 1 blade ribbon type



MILTEX Stitch Scissors

MDC-61-114

Gum Scissors Curved sharp pointed tips ribbon

type



MILTEX Stitch Scissors

MDC-61-115

Gum Scissors Curved sharp pointed tips ribbon

type



VANTAGE Crown Scissors

MDC-61-116

Gum Scissors Collar curved



VANTAGE Collar

MDC-61-117

Gum Scissors Crown Scissors straight



MILTEX Wire Cutting Scissors

MDC-61-118

Gum Scissors Angled to side one serrated

blade

Gum Scissors



MILTEX Wire Cutting Scissors

MDC-61-119

Gum Scissors Angled to side, one serrated blade, Carb-N-Sert inserts



Standard Pattern Operating Scissors

MDC-61-120

Gum Scissors Straight sharp-sharp points



Standard Pattern Operating Scissors

MDC-61-121

Gum Scissors Straight sharp-sharp points



Standard Pattern Operating Scissors

MDC-61-122

Gum Scissors Straight sharp-blunt points



Standard Pattern Operating Scissors

MDC-61-123

Gum Scissors Straight sharp-blunt points



Standard Pattern Operating Scissors

MDC-61-124

Gum Scissors Straight sharp-blunt points

Gum Scissors



Standard Pattern Operating Scissors

MDC-61-125

Gum Scissors Curved sharp/sharp points



Standard Pattern Operating Scissors

MDC-61-126

Gum Scissors Curved sharp/sharp points



Standard Pattern Operating Scissors

MDC-61-127

Gum Scissors Curved



Standard Pattern Operating Scissors

MDC-61-128

Gum Scissors Curved, sharp-blunt points



MAYO Dissecting Scissors

MDC-61-129

Gum Scissors Straight, standard beveled blades



MAYO Dissecting Scissors

MDC-61-130

Gum Scissors Straight, standard beveled blades

Gum Scissors



MAYO Dissecting Scissors

MDC-61-131

Gum Scissors Curved, standard beveled blades



MAYO Dissecting Scissors

MDC-61-132

Gum Scissors Curved, standard beveled blades



Delicate Pattern METZENBAUM Scissors

MDC-61-133

Gum Scissors Straight, blunt points
5-1/2" (14cm)



Delicate Pattern METZENBAUM Scissors

MDC-61-134

Gum Scissors Straight, sharp points
5-1/2" (14cm)



Standard Pattern METZENBAUM Scissors

MDC-61-135

Gum Scissors
Curved, blunt points



Standard Pattern METZENBAUM Scissors

MDC-61-136

Gum Scissors
Curved, blunt points

Gum Scissors



Delicate Pattern METZENBAUM Scissors

MDC-61-137

Gum Scissors Curved, blunt points
5-1/2" (14cm)



Delicate Pattern METZENBAUM Scissors

MDC-61-138

Gum Scissors Curved, sharp points
5-1/2" (14cm)



KELLY Scissors

MDC-61-139

Gum Scissors
Straight, sharp points



KELLY Scissors

MDC-61-140

Gum Scissors
Curved, sharp points



KELLY Scissors

MDC-61-141

Gum Scissors
Sharp points, angled on side



KAYE Blepharoplasty And Dissecting Scissors

MDC-61-142

Gum Scissors One serrated blade, ribbon type
4-1/2" (10.58cm)

Gum Scissors



DEAN Dissecting Scissors

MDC-61-143

Gum Scissors Blades angled on flat, one serrated blade
6-3/4" (17.5cm)



KAYE Dissecting Scissors

MDC-61-144

Gum Scissors Curved, one serrated blade
4-17/32" (11.5 cm)



WAGNER Plastic Surgery Scissors

MDC-61-145

Gum Scissors
Straight, sharp-sharp points, serrated blade



WAGNER Plastic Surgery Scissors

MDC-61-146

Gum Scissors
Straight, sharp-sharp points, serrated blade



WAGNER Plastic Surgery Scissors

MDC-61-147

Gum Scissors
Straight, sharp-blunt points



WAGNER Plastic Surgery Scissors

MDC-61-148

Gum Scissors
Straight, sharp-blunt points, serrated blade

Gum Scissors



WAGNER Plastic Surgery Scissors

MDC-61-149

Gum Scissors

Straight, blunt-blunt points



WAGNER Plastic Surgery Scissors

MDC-61-150

Gum Scissors

Straight, blunt-blunt points, serrated blade



WAGNER Plastic Surgery Scissors

MDC-61-151

Gum Scissors

Curved, sharp-sharp points



WAGNER Plastic Surgery Scissors

MDC-61-152

Gum Scissors

Curved, sharp-sharp points, serrated blade



WAGNER Plastic Surgery Scissors

MDC-61-153

Gum Scissors

Curved, sharp-blunt points



WAGNER Plastic Surgery Scissors

MDC-61-154

Gum Scissors

Curved, sharp-blunt points, serrated blade

Gum Scissors



WAGNER Plastic Surgery Scissors

MDC-61-155

Gum Scissors

Curved, blunt-blunt points



WAGNER Plastic Surgery Scissors

MDC-61-156

Gum Scissors

Curved, blunt-blunt points, serrated blade



WAGNER Plastic Surgery Scissors

MDC-61-157

Gum Scissors

Straight, sharp-sharp points



WAGNER Plastic Surgery Scissors

MDC-61-158

Gum Scissors

Straight, sharp-sharp point, serrated blade



Delicate Pattern METZENBAUM Scissors

MDC-61-159

Gum Scissors Curved

5" (12.7cm)



Iris Scissors

MDC-61-160

Gum Scissors Straight

4" (10.2cm)

Gum Scissors



Iris Scissors

MDC-61-161

Gum Scissors Curved
4" (10.5cm)



Iris Scissors

MDC-61-162

Gum Scissors Straight
4-1/2" (10.58cm)



Iris Scissors

MDC-61-163

Gum Scissors Straight
4-1/2" (10.58cm)



Iris Scissors

MDC-61-164

Gum Scissors Curved
4-1/2" (10.58cm)



Iris Scissors

MDC-61-165

Gum Scissors Curved
4-1/2" (10.58cm)



Iris Scissors

MDC-61-166

Gum Scissors Angled on side
4-1/2" (10.58cm)

Gum Scissors



BROPHY Scissors

MDC-61-167

Gum Scissors Straight, sharp points
5-1/2" (14cm)



BROPHY Scissors

MDC-61-168

Gum Scissors Curved, sharp points
5-1/2" (14cm)



GOLDMAN-FOX Scissors

MDC-61-169

Gum Scissors Curved fine tips, one serrated
blade
4" (10.5cm)



GOLDMAN-FOX Scissors

MDC-61-170

Gum Scissors Curved fine tips, one serrated
blade
5-1/2" (14cm)



KELLY Scissors

MDC-61-171

Gum Scissors Sharp points, straight, one
serrated blade
6-1/4" (15.9 cm)



KELLY Scissors

MDC-61-172

Gum Scissors
Sharp points, curved, one serrated blade

Gum Scissors



KELLY Scissors

MDC-61-173

Gum Scissors

Sharp points, angular, one serrated blade



Iris Operating Scissors

MDC-61-174

Gum Scissors Curved sideways

4-3/5" (14cm)



GOLDMAN-FOX Scissors

MDC-61-175

Gum Scissors Curved, one serrated blade,
angled shank

4-1/2" (10.58cm)



LA GRANGE Scissors

MDC-61-176

Gum Scissors

Curved, one serrated blade, angled shank



BROPHY Operating Scissors

MDC-61-177

Gum Scissors Curved, sharp/sharp, with one
serrated blade

5-1/2" (14cm)



LOCKLIN Operating Scissors

MDC-61-178

Gum Scissors

Angled on side 25 degrees, one serrated blade



LOCKLIN Operating Scissors

MDC-61-179

Gum Scissors

Curved shank, angled on side 25 degrees, one serrated blade



MILTEX SuperCut GOLDMAN-FOX Gum Scissors

MDC-61-180

Gum Scissors

Curved



HEATH Suture Scissors

MDC-61-181

Gum Scissors Serrated blade

6-1/8" (15.6cm)



Iris Scissors

MDC-61-182

Gum Scissors Straight, with 20 mm blades, delicate

3-1/2" (8.9 cm)



Iris Scissors

MDC-61-183

Gum Scissors Curved, with 20 mm blades, delicate

3-1/2" (8.9 cm)



NOYES (ROSS) Iris Scissors

MDC-61-184

Gum Scissors

Curved, sharp/sharp points

Gum Scissors



CASTROVIEJO Corneal Scissors

MDC-61-185

Gum Scissors Curved, sharp points
4-3/4" (.5cm)



QUIMBY Gum Scissors

MDC-61-186

Gum Scissors
Strongly curved and pointed, smooth blades 15
mm



JOSEPH Scissors

MDC-61-187

Gum Scissors Straight
5-1/2" (14cm)



JOSEPH Scissors

MDC-61-188

Gum Scissors Curved
5-1/2" (14cm)

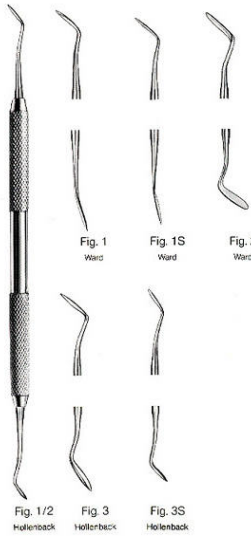

Hollenback

MDC-62-101

Amalgam Instruments

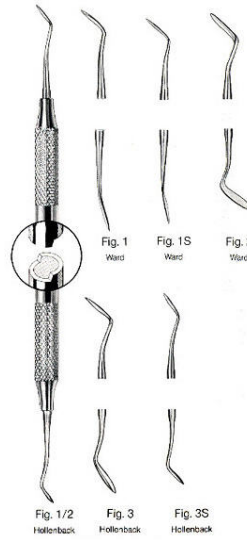

Hollenback

MDC-62-107

Amalgam Instruments



Mortonson 1

MDC-62-113

Amalgam Instruments



Fig. 2

Amalgam Instruments

MDC-62-114

Amalgam Instruments

Fig -2



Fig 3

Amalgam Instruments

MDC-62-115

Amalgam Instruments

Fig -3



Fig 4

Amalgam Instruments

MDC-62-116

Amalgam Instruments

Fig -4



Fig. 3-SHO

Amalgam Instruments

MDC-62-118

Amalgam Instruments

Fig -3-SHO



Fig. SHO-A

Amalgam Instruments

MDC-62-117

Amalgam Instruments

Fig -SHO-A



Fig. 104

Amalgam Instruments

MDC-62-119

Amalgam Instruments

Fig-104



Fig. 8

Amalgam Instruments

MDC-62-120

Amalgam Instruments

Fig -8



Fig. 1

Amalgam Instruments

MDC-62-121

Amalgam Instruments

Fig -1



Fig. 2

Amalgam Instruments

MDC-62-122

Amalgam Instruments

Fig -2



Fig 3

Amalgam Instruments

MDC-62-123

Amalgam Instruments

Fig -3



Fig 4

Amalgam Instruments

MDC-62-124

Amalgam Instruments

Fig -4



Fig SHO-A

Amalgam Instruments

MDC-62-125

Amalgam Instruments

Fig -SHO-A



Fig. 3-SHO

Amalgam Instruments

MDC-62-126

Amalgam Instruments

Fig -3-SHO



Fig. 104

Amalgam Instruments

MDC-62-127

Amalgam Instruments

Fig -104



Fig. 8

Amalgam Instruments

MDC-62-128

Amalgam Instruments

Fig -8



Fig. 1

Amalgam Instruments

MDC-62-129

Amalgam Instruments

Fig -1



Fig. 2

Amalgam Instruments

MDC-62-130

Amalgam Instruments

Fig -2



Fig. 3

Amalgam Instruments

MDC-62-131

Amalgam Instruments

Fig -3



Fig. 4

Amalgam Instruments

MDC-62-132

Amalgam Instruments

Fig -4



Fig. 1

Amalgam Instruments

MDC-62-133

Amalgam Instruments

Fig -1



Fig. 2

Amalgam Instruments

MDC-62-134

Amalgam Instruments

Fig -2



Fig. 3

Amalgam Instruments

MDC-62-135

Amalgam Instruments

Fig -3



Fig. 4

Amalgam Instruments

MDC-62-136

Amalgam Instruments

Fig -4



Ivory Fig. 8
5 mm
6 mm
7 mm

Toffemire-Universal

MDC-62-137

Amalgam Instruments



Nystrom I + II
Ivory Fig. 1
Ivory Fig. 12

Amalgam Instruments

MDC-62-142

Amalgam Instruments
Levory Fig -1
Levory Fig -2



Amalgam Instruments

MDC-62-143

Amalgam Pistolen
210mm



Amalgam Instruments

MDC-62-144

Amalgam Pistolen
185mm



Amalgam Instruments

MDC-62-145

Amalgam Pistolen



Amalgam Instruments

MDC-62-146

Amalgam Pistolen
145mm



Amalgam Carrier

MDC-62-147

Amalgam Carrier
Fig -1Fig -2Fig -4Fig -5



Amalgam Carrier

MDC-62-148

Amalgam Carrier
Fig -1Fig -2Fig -3



Amalgam Carrier

MDC-62-149

Amalgam Carrier
Fig -1Fig -2Fig -3



Heister

MDC-63-141
Mouth Gags,
5"130mm



MOLT PEDIATRIC

MDC-63-142
Mouth Gags,
4"100mm



MOLT CHILD

MDC-63-143
Mouth Gags,
120 mm4"



MOLT ADULT

MDC-63-144
Mouth Gags,
9"140mm



FERGUSSON-ACKLAND

MDC-63-145
Mouth Gags,
145mm5"



DENHART

MDC-63-146
Mouth Gags,
5"125 mm



ROSER-KONIG

MDC-63-148

Mouth Gags,
7"185mm



LANGENBECK

MDC-63-149

Finger Protectors
7"180mm



**Tongue Depressor And Cheek
Retractors**

MDC-63-150

Tongue Depressor and Cheek Retractors



Retractor

MDC-63-151

Mouth Gags,



HARTMANN

MDC-63-152

Retractors
145mm5"



Retractor

MDC-63-153

Mouth Gags,
5"140mm

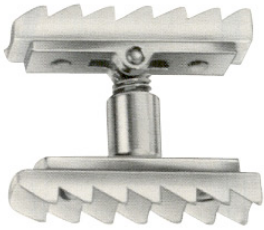

SCHMID
MDC-63-154
Mouth Gags,



Retractor
MDC-63-155
Mouth Props
5"140mm



Retractor
MDC-63-156
Retractors
6"160mm



VESTIBULUM RETRACTOR
MDC-63-157
Retractors



STERNBERG
MDC-63-158
Retractors



ROUX
MDC-63-159
Retractors
23cm 36 x 30



ROUX
MDC-63-160
Retractors



ROUX
MDC-63-161
Retractors



MIDDELDORPF
MDC-63-162
Retractors
200mm



MIDDELDORPF
MDC-63-163
Retractors
8"210mm



MIDDELDORPF
MDC-63-164
Cheek Retractors
9"230mm



Gauze Case
MDC-63-165
Gauze Case
9"26x30mm230mm



Retractor

MDC-63-166

Retractors
5"165mm



Retractor

MDC-63-167

Retractor
6"165mm



Retractor

MDC-63-168

Retractor
6"165mm



Retractor

MDC-63-169

Retractor
6"165mm



Retractor

MDC-63-170

Retractor
6"165mm



Retractor

MDC-63-171

Retractor
6"165mm



Retractor
MDC-63-172
Retractors
6"165mm



Retractor
MDC-63-173
Retractors
6"165mm

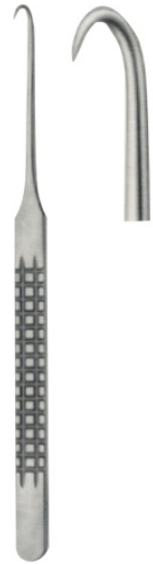

Retractor
MDC-63-174
Retractors
6"160mm



Retractor
MDC-63-175
Retractors
6"160mm



LANGENBECK-GREEN
MDC-63-176
Retractors



Fig. 72
1942/1952
Kirkland

Kirkland

MDC-64-101

Periodontia Instruments



Fig. 172
Orban

Orban

MDC-64-102

Periodontia Instruments



Fig. 172
Orban

Orban

MDC-64-104

Periodontia Instruments



Fig. 7
Goldman-Fox

Goldman-Fox

MDC-64-105

Periodontia Instruments



Fig. 8
Goldman-Fox

Goldman-Fox

MDC-64-106

Periodontia Instruments



Fig. 9
Goldman-Fox

Goldman-Fox

MDC-64-107

Periodontia Instruments



Fig. 1/2
Kirkland

Kirkland

MDC-64-103

Periodontia Instruments



Fig 11
Goldman-Fox

Goldman-Fox

MDC-64-108

Periodontia Instruments



Fig 3/4
Buck

Buck

MDC-64-109

Periodontia Instruments

Fig -3/4



Fig. 5/6
Buck

Buck

MDC-64-110

Periodontia Instruments

Fig -5/6



Fig. 7
Goldman-Fox

Goldman-Fox

MDC-64-111

Periodontia Instruments



Fig. 8
Goldman-Fox

Goldman-Fox

MDC-64-112

Periodontia Instruments



Fig. 9
Goldman-Fox

Goldman-Fox

MDC-64-113

Periodontia Instruments



Fig. 11
Goldman-Fox

Goldman-Fox

MDC-64-114

Periodontia Instruments



Fig. 3/4
Buck

Buck

MDC-64-115

Periodontia Instruments

Fig -3/4



Fig. 5/6
Buck

Buck

MDC-64-116

Periodontia Instruments

Fig -5/6



Fig. 1/2
Sanders

Sanders

MDC-64-117

Periodontia Instruments



Fig. 4/5
Sanders

Sanders

MDC-64-118

Periodontia Instruments



Fig. 18/20

OCHSENBEIN CHISEL NO 4

MDC-64-119

Periodontia Instruments



Fig. 5/6
Back

Crane-Kaplan

MDC-64-120

Periodontia Instruments

Fig -5/6



Fig. 1/2
Seslin.

Sanders

MDC-64-121

Periodontia Instruments



Fig. 4/5
Sanders

Sanders

MDC-64-122

Periodontia Instruments



Fig. 18/20

OCHSENBEIN CHISEL NO 4

MDC-64-123

Periodontal Instruments



Fig. CK3
Crane-Kaplan

Crane-Kaplan

MDC-64-124

Periodontia Instruments

Fig -CK3



Fig. -HU 1/2
Curette

Curette

MDC-64-125

Periodontia Instruments

Fig -HU 1/2



Fig. 2R/2L
Columbia

Columbia

MDC-64-126

Periodontia Instruments

Fig -2R/2L



Fig. 4R/4L
Columbia

Columbia

MDC-64-127

Periodontia Instruments

Fig -4A/4L



Fig. 13/14
Columbia

Columbia

MDC-64-128

Periodontia Instruments

Fig -13/14



Fig. 411/412

Periodontia Instruments

MDC-64-129

Periodontia Instruments



Fig. 413/414

Periodontia Instruments

MDC-64-130

Periodontia Instruments



Zerling-Chiles

Zerling-Chiles

MDC-64-131

Periodontia Instruments



Fig. HU 1/2
Curette

Curette

MDC-64-132

Periodontia Instruments

Fig -HU 1/2



Fig. 2R/2L
Columbia

Columbia

MDC-64-133

Periodontia Instruments

Fig -2R/2L



Fig. 4R/4L
Columbia

Columbia

MDC-64-134

Periodontia Instruments

Fig -4A/4L



Fig. 13/14
Columbia

Columbia

MDC-64-135

Periodontia Instruments

Fig -13/14



Fig. 1/2
Langer

Langer

MDC-64-136

Periodontia Instruments



Fig. 3/4
Langer

Langer

MDC-64-137

Periodontia Instruments



Fig. 1/2
Barnhart

Barnhart

MDC-64-138

Periodontia Instruments

Fig -1/2



Fig. 5/6
Barnhart

Barnhart

MDC-64-139

Periodontia Instruments

Fig -5/6



Fig. ME-1
(20/11)

Periodontia Instruments

MDC-64-140

Periodontia Instruments



Fig. 3/4
Hue (23/25)

Periodontia Instruments

MDC-64-141

Periodontia Instruments



Fig. 1/2
Langer

Langer

MDC-64-142

Periodontia Instruments



Fig. 3/4
Langer

Langer

MDC-64-143

Periodontia Instruments



Fig. 1/2
Barnhart

Barnhart

MDC-64-144

Periodontia Instruments

Fig -1/2



Fig. 5/6
Barnhart

Barnhart

MDC-64-145

Periodontia Instruments

Fig -5/6



Fig ME-1
[10/11]

Periodontia Instruments

MDC-64-146

Periodontia Instruments



Fig. 3/4
Rue [22/24]

Periodontia Instruments

MDC-64-147

Periodontia Instruments



Fig. 1/2
Gracey

Gracey

MDC-64-148

Periodontia Instruments



Fig. 3/4
Gracey

Gracey

MDC-64-149

Periodontia Instruments



Fig. 5/6
Gracey

Gracey

MDC-64-150

Periodontia Instruments



Fig. 7/8
Gracey

Gracey

MDC-64-151

Periodontia Instruments



Fig. 9/10
Gracey

Gracey

MDC-64-152

Periodontia Instruments



Fig. 11/12
Gracey

Gracey

MDC-64-153

Periodontia Instruments



Fig. 13/14
Gracey

Gracey

MDC-64-154

Periodontia Instruments



Fig. 1/2
Gracey

Gracey

MDC-64-155

Periodontia Instruments



Fig. 3/4
Gracey

Gracey

MDC-64-156

Periodontia Instruments



Fig. 5/6
Gracey

Gracey

MDC-64-157

Periodontia Instruments



Fig. 7/8
Gracey

Gracey

MDC-64-158

Periodontia Instruments



Fig. 9/10
Gracey

Gracey

MDC-64-159

Periodontia Instruments



Fig. 11/12
Gracey

Gracey

MDC-64-160

Periodontia Instruments



Fig. 13/14
Gracey

Gracey

MDC-64-161

Periodontia Instruments



Fig. 11/14
Gracey

Gracey

MDC-64-162

Periodontia Instruments



Fig. 12/13
Gracey

Gracey

MDC-64-163

Periodontia Instruments



Fig. 1
De Marco

Ce Marco

MDC-64-164

Periodontia Instruments

Fig -1



Fig. 2
De Marco

De Marco

MDC-64-165

Periodontia Instruments

Fig -1



Fig. 13/14
Anterior

Anterior

MDC-64-166

Periodontia Instruments

Fig -13/14



Fig. 17/18
Posterior

Posterior

MDC-64-167

Periodontia Instruments



Fig. 1 / 14
Gracey

Gracey

MDC-64-168

Periodontia Instruments



Fig. 12/13
Gracey

Gracey

MDC-64-169

Periodontia Instruments



Fig. 1
De Marco

De Marco

MDC-64-170

Periodontia Instruments

Fig -1



Fig 2
De Marco

De Marco

MDC-64-171

Periodontia Instruments

Fig -2



Fig. 13/14
Anterior

Anterior

MDC-64-172

Periodontia Instruments

Fig -13/14



Fig. 17/18
Posterior

Posierior

MDC-64-173

Periodontia Instruments



Fig. 1
Goldman-Fox

Goldman-Fox

MDC-64-174

Periodontia Instruments



Fig. 2
Goldman-Fox

Goldman-Fox

MDC-64-175

Periodontia Instruments



Fig. 3
Goldman-Fox

Goldman-Fox

MDC-64-176

Periodontia Instruments



Fig. 4
Goldman-Fox

Goldman-Fox

MDC-64-177

Periodontia Instruments



Fig. 5
Goldman-Fox

Goldman-Fox

MDC-64-178

Periodontia Instruments



Fig. 6
Goldman-Fox

Goldman-Fox

MDC-64-179

Periodontia Instruments



Fig. 21
Goldman-Fox

Goldman-Fox

MDC-64-180

Periodontia Instruments



Fig. 1
Goldman-Fox

Goldman-Fox

MDC-64-181

Periodontia Instruments



Fig. 2
Goldman-Fox

Goldman-Fox

MDC-64-182

Periodontia Instruments



Fig. 3
Goldman-Fox

Goldman-Fox

MDC-64-183

Goldman-Fox



Fig. 4
Goldman-Fox

Goldman-Fox

MDC-64-184

Periodontia Instruments



Fig. 5
Goldman-Fox

Goldman-Fox

MDC-64-185

Periodontia Instruments



Fig. 6
Goldman-Fox

Goldman-Fox

MDC-64-186

Periodontia Instruments



Fig. 21
Goldman-Fox

Goldman-Fox

MDC-64-187

Periodontia Instruments



Fig. 11/12
Mc Call

Mc Call

MDC-64-188

Periodontia Instruments



Fig. 11A/12A
Mc Call

Mc Call

MDC-64-189

Periodontia Instruments



Fig. 13/14
Mc Call

Mc Call

MDC-64-190

Periodontia Instruments



Fig. 13S/14S
Mc Call

Mc Call

MDC-64-191

Periodontia Instruments



Fig. 175/18S
Mc Call

Mc Call

MDC-64-192

Periodontia Instruments



Fig. 19/20
Mc Call

Mc Call

MDC-64-193

Periodontia Instruments



Fig. 11/12
Mc Call

Mc Call

MDC-64-194

Periodontia Instruments



Fig. 11A/12A
Mc Call

Mc Call

MDC-64-195

Periodontia Instruments



Fig. 13/14
Mc Call

Mc Call

MDC-64-196

Periodontia Instruments



Fig. 13S/14S
Mc Call

Mc Call

MDC-64-197

Periodontia Instruments



Fig. 17S/18S
Mc Call

Mc Call

MDC-64-198

Periodontia Instruments



Fig. 19/20
Mc Call

Mc Call

MDC-64-199

Periodontia Instruments



Fig. 2/3
Taylor

Taylor

MDC-64-200

Periodontia Instruments



Fig. 204S

Periodontia Instruments

MDC-64-202

Periodontia Instruments



Fig. 204S

Periodontia Instruments

MDC-64-203

Periodontia Instruments



Fig. 6
Crane-Kaplan

Crane-Kaplan

MDC-64-204

Periodontia Instruments

Fig -6



Fig. 77/3
Younger-Good

Younger-Good

MDC-64-205

Periodontia Instruments



Fig. 213
Taylor

Taylor

MDC-64-206

Periodontia Instruments



Fig. 204

Periodontia Instruments

MDC-64-207

Periodontia Instruments



Fig. 204G

Periodontia Instruments

MDC-64-208

Periodontia Instruments



Fig 204S

Periodontia Instruments

MDC-64-209

Periodontia Instruments



Fig. 6
Crane-Kaplan

Crane-Kaplan

MDC-64-210

Periodontia Instruments

Fig -6



Fig. 7/8
Younger-Good

Younger-Good

MDC-64-211

Periodontia Instruments



Fig. 3/7
Hirschfeld

Hirschfeld

MDC-64-212

Periodontia Instruments



Fig. 28/31
Jaquette

Jaquette

MDC-64-213

Periodontia Instruments



Fig. 31/32
Jaquette

Jaquette

MDC-64-214

Periodontia Instruments



Fig. 31/33
Jaquette

Jaquette

MDC-64-215

Periodontia Instruments



Fig. 2/7
Hirschfeld

Hirschfeld

MDC-64-216

Periodontia Instruments



Fig. 30/33
Jaquette

Jaquette

MDC-64-217

Periodontia Instruments



Fig. 31/32
Jaquette

Jaquette

MDC-64-218

Periodontia Instruments



Fig. 34/35
Jaquette

Jaquette

MDC-64-219

Periodontia Instruments



Fig. 37/38
Jaquette

Jaquette

MDC-64-220

Periodontia Instruments



Fig. 1
Ochsenbein

Ochsenbein

MDC-64-221

Periodontia Instruments



Fig. 2
Ochsenbein

Ochsenbein

MDC-64-222

Periodontia Instruments



Fig. 1
Gardner

Gardner

MDC-64-223

Periodontia Instruments

Fig -1



Fig. 2
Gardner

Gardner

MDC-64-224

Periodontia Instruments



Fig. 5
Gardner

Gardner

MDC-64-225

Periodontia Instruments



Fig. 5R
Gardner

Gardner

MDC-64-226

Periodontia Instruments



Fig. 6
Gardner

Gardner

MDC-64-227

Periodontia Instruments



Fig. 1W
Wakel old

Wakel Old

MDC-64-228

Periodontia Instruments



Fig. 2W
Wakel old

Wakel Old

MDC-64-229

Periodontia Instruments



Fig. 3
Buckley

Buckley

MDC-64-230

Periodontia Instruments

Fig -3



Fig. M3
Molt

Molt

MDC-64-231

Periodontia Instruments



Fig. PR3
Prichard

Prichard

MDC-64-232

Periodontia Instruments



Fig. H
Hopkins

Hopkins

MDC-64-233

Periodontia Instruments



Fig. 2
Hopkins

Hopkins

MDC-64-234

Periodontia Instruments



Fig. 15
Frerr

Frerr

MDC-64-235

Periodontia Instruments

Fig -5



Fig. 16
Frerr

Frerr

MDC-64-236

Periodontia Instruments

Fig -16



Fig. 3
Mead

Mead

MDC-64-237

Periodontia Instruments



Fig. 23
Seldin Retractor

Seldin Retractor

MDC-64-238

Periodontia Instruments



Williger
c/n. 17

Williger

MDC-64-239

Periodontia Instruments



Williger
cm. 16

Williger

MDC-64-240

Periodontia Instruments



Williger
cm. 16

Williger

MDC-64-241

Periodontia Instruments



Williger
cm. 13

Williger

MDC-64-242

Periodontia Instruments



Fig. 1S/2S
Sugarman

Sugarman

MDC-64-243

Periodontia Instruments



Fig. 3S/4S
Sugarman

Sugarman

MDC-64-244

Periodontia Instruments



Fig. 1/2
TG Chsel

TG Chsel

MDC-64-245

Periodontia Instruments



Fig. 1/2
TG Chisel

TG Chsel

MDC-64-246

Periodontia Instruments



Fig. 1
TG Chisel

TG Chsel

MDC-64-247

Periodontia Instruments



Fig. 2
TG Chisel

TG Chsel

MDC-64-248

Periodontia Instruments



Fig. 1
(15K)
Kirkland

Kirkland

MDC-64-249

Periodontia Instruments



Fig. 2
(16K)
Kirkland

Kirkland

MDC-64-250

Periodontia Instruments



Fig. 1
Orban

Orban

MDC-64-251

Periodontia Instruments

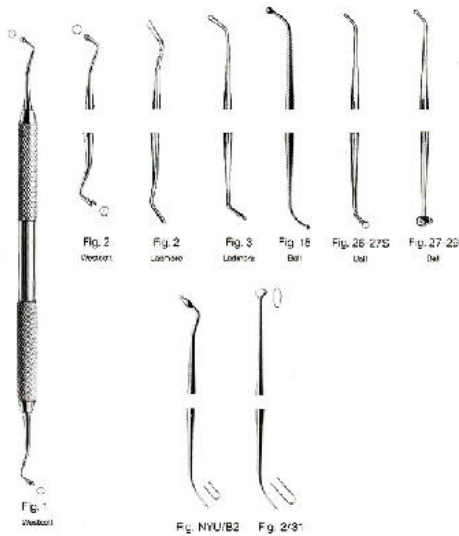

Fig. 2
Orban

Orban

MDC-64-252

Periodontia Instruments



Westcott

MDC-65-101

Filling instruments

Fig -1

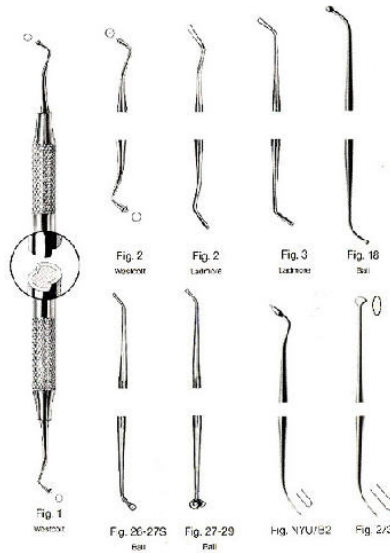

Westcott

MDC-65-110

Filling instruments

Fig -1

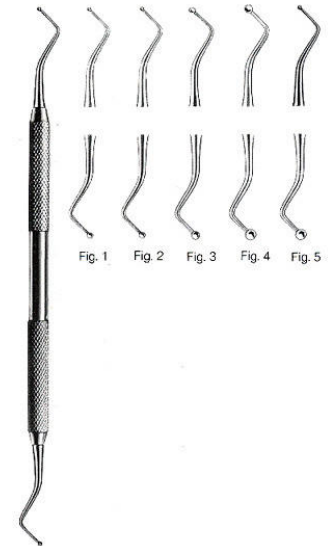

Filling Instruments

MDC-65-119

Filling instruments

Fig -1 Fig -2 Fig -4 Fig -5 Fig -3

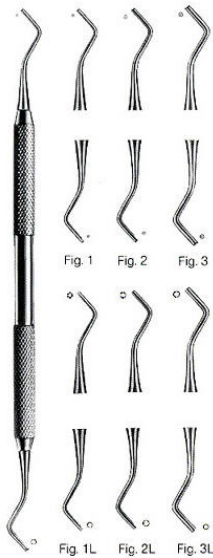

Filling Instruments

MDC-65-125

Filling instruments

Fig -1 Fig -2 Fig -3

Cement Spatulas



No. 22 Cement Spatula
MDC-66-101
No. 22 Cement Spatula



No. 24A Cement Spatula, Rigid
MDC-66-102
No. 24A Cement Spatula, Rigid



No. 24 Cement Spatula, Flexible
MDC-66-103
No. 24 Cement Spatula, Flexible



No. 313 Cement Spatula,
MDC-66-104
No. 313 Cement Spatula,



No. 5 Cement Spatula
MDC-66-105
No. 5 Cement Spatula



No. 7 Cement Spatula
MDC-66-106
No. 7 Cement Spatula

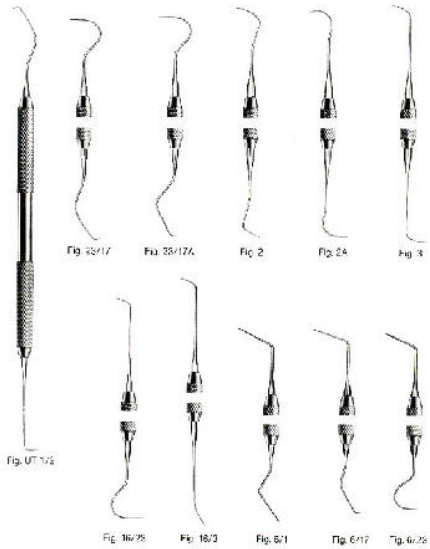

Single Ended / Double Ended Explorers

MDC-67-101

Single Ended / Double Ended Explorers
Fig -UT 1/2

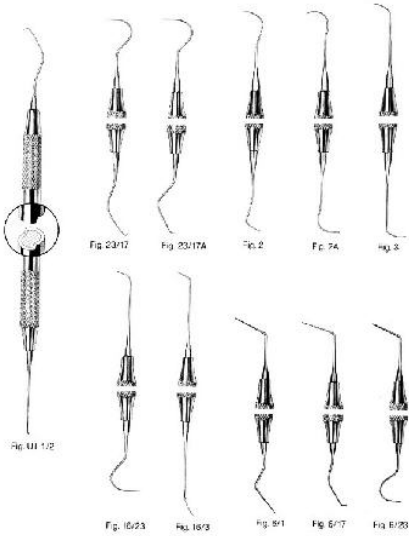

Single Ended / Double Ended Explorers

MDC-67-112

Single Ended / Double Ended Explorers
Fig -UT 1/2

Mirror Handles



SIMPLE STEM PLANE 4

MDC-68-113
MOUTH MIRROR



SIMPLE STEM PLANE 5

MDC-68-114
MOUTH MIRROR



SIMPLE STEM PLANE 4

MDC-68-115
MOUTH MIRROR



SIMPLE STEM PLANE 4

MDC-68-116
MOUTH MIRROR



SIMPLE STEM PLANE 4

MDC-68-117
MOUTH MIRROR



SECO / CONE-SOCKET

MDC-68-118
Mirror Handles
5"125 mm

Mirror Handles



OCTOGONAL CONE SOCKET

MDC-68-119
Mirror Handles
120 mm4"



MARTIN ERGO

MDC-68-120
Mirror Handles
5"135mm



Mirror Handles

MDC-68-121
Mirror Handles
5"135mm



Mirror Handles

MDC-68-122
Mirror Handle
5"135mm



Mirror Handles

MDC-68-123
Mirror Handles
5"135mm



Mirror Handles

MDC-68-124
Mirror Handles
5"135mm



Napkin Holder

MDC-68-131
Napkin Holder
? 50 mm



Laryngeal Mirrors

MDC-68-129
MIRROR HANDLES
7 mm 30?? 4



Cotton Wool Container

MDC-68-130
Cotton Wool Container
? 50 mm



Laryngeal Mirrors

MDC-68-128
MIRROR HANDLES
7 mm 30?? 4



MIRROR HANDLE CONE SOCKET

MDC-53-721-01
MIRROR HANDLES
14cm/5



MIRROR HANDLE CONE SOCKET

MDC-53-721-02
MIRROR HANDLE CONE SOCKET
14cm/5



MIRROR HANDLE CONE SOCKET

MDC-53-723-01

MIRROR HANDLES

13cm/5



MIRROR HANDLE

MDC-53-728-02

MIRROR HANDLES

12cm



MARTIN-GRIP

MDC-53-746-02

12cm



MIRROR HANDLE

MDC-53-755-02

MIRROR HANDLES

14cm



MIRROR HANDLE

MDC-53-757-08

MIRROR HANDLES

14cm/5



MIRROR

MDC-53-702-22

Mirror Handles



MIRROR
MDC-53-703-22



RHODIUM MIRROR
MDC-53-704-10
MIRROR



RHODIUM MIRROR
MDC-53-704-18
MIRROR

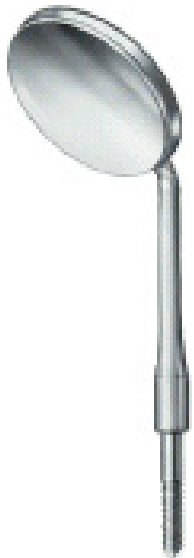

CONE SOCKET
MDC-53-706-22
MIRROR



CONE SOCKET
MDC-53-707-22
MIRROR



MICRO-MOUTH MIRROR
MDC-53-710-03

Fig -1

Mirror Handles



MICRO-MOUTH MIRROR

MDC-53-710-05

Fig -1

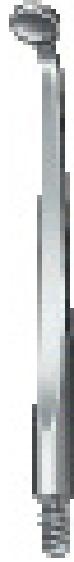

RHODIUM MICRO MIRROR

MDC-53-711-03

Fig -1



HILGER

MDC-53-715-00

18cm /7



HILGER

MDC-53-715-01

CHEEK RETRACTORS



Fig. 1
Spreader

Root Spreader Fig 1

MDC-69-101

Endodontic Instruments

Fig -1



Fig. 2
Spreader

Root Spreader Fig 2

MDC-69-102

Endodontic Instruments

Fig -2



Fig. 2
Spreader

Root Spreader Fig 3

MDC-69-103

Endodontic Instruments

Fig -3



Fig. 4
Spreader

Root Spreader Fig 4

MDC-69-104

Endodontic Instruments

Fig -4



Fig. 5
Spreader

Root Spreader Fig 5

MDC-69-105

Endodontic Instruments

Fig -5



Fig. 6
Spreader

Root Spreader Fig 6

MDC-69-106

Endodontic Instruments

Fig -6



Fig. 7
Spreader

Root Spreader Fig 7

MDC-69-107

Endodontic Instruments

Fig -7



Fig. 1
Luks

Luks Fig 1

MDC-69-108

Endodontic Instruments

Fig -1



Fig. 2

LUKS Fig 2

MDC-69-109

Endodontic Instruments

Fig -2



Fig. 3

LUKS Fig 3

MDC-69-110

Endodontic Instruments

Fig -3



Fig. 4

LUKS Fig 4

MDC-69-111

Endodontic Instruments

Fig -4



Fig. 1

Vertical Condenser Fig 1

MDC-69-112

Endodontic Instruments

Fig -1



Fig. 2

Vertical Condenser Fig 2

MDC-69-113

Endodontic Instruments

Fig -2



Fig. 3

Vertical Condenser Fig 3

MDC-69-114

Endodontic Instruments

Fig -3



Fig. 6/1

Root Canal Explorer Fig 6/1

MDC-69-116

Endodontic Instruments

Fig -6/1



Fig. 6/17

Root Canal Explorer Fig 6/17

MDC-69-117

Endodontic Instruments

Fig -6/17



Fig. 6/23

Root Canal Explorer Fig 6/23

MDC-69-118

Endodontic Instruments

Fig -6/23



Fig. 31L

Root Canal Excavators Fig 31L

MDC-69-119

Endodontic Instruments

Fig -31



Fig. 32L

Root Canal Excavators Fig 32L

MDC-69-120

Endodontic Instruments

Fig -32L



Fig. 33L

Root Canal Excavators Fig 33L

MDC-69-121

Endodontic Instruments

Fig -33L



Fig. 6/1

Root Canal Explorers Fig 6/1

MDC-69-122

Endodontic Instruments

Fig -6/1



Fig. 6/17

Root Canal Explorers Fig 6/17

MDC-69-123

Endodontic Instruments

Fig -6/17



Fig. 6/23

Root Canal Explorers Fig 6/23

MDC-69-124

Endodontic Instruments

Fig -6/23



Fig. 31L

Root Canal Excavators Fig 31L

MDC-69-125

Endodontic Instruments

Fig -31L



Fig. 32L

Root Canal Excavators Fig 32L

MDC-69-126

Endodontic Instruments

Fig -32L



Fig. 33L

Root Canal Excavators Fig 33L

MDC-69-127

Endodontic Instruments

Fig -33L

Separating Spatulas



Heidemann

MDC-70-101

Separating Spatulas

Fig -1



Heidemann

MDC-70-102

Separating Spatulas

Fig -2



Heidemann

MDC-70-104

Separating Spatulas

Fig -4



Heidemann

MDC-70-105

Separating Spatulas

Fig -5



Heidemann

MDC-70-106

Separating Spatulas

Fig -6



Heidemann

MDC-70-107

Separating Spatulas

Fig -7

Separating Spatulas



Heidemann

MDC-70-108

Separating Spatulas

Fig -8



Heidemann

MDC-70-109

Separating Spatulas

Fig -9



Heidemann

MDC-70-110

Separating Spatulas

Fig -1



Heidemann

MDC-70-111

Separating Spatulas

Fig -2



Heidemann

MDC-70-112

Separating Spatulas

Fig -3

Excavators



Fig. 0

Excavators Fig 0

MDC-71-101

Excavators



Fig. 1

Excavators Fig 1

MDC-71-102

Excavators

Fig -1



Fig. 2

Excavators Fig 2

MDC-71-103

Excavators

Fig -2



Fig. 3

Excavators Fig 3

MDC-71-104

Excavators

Fig -3



Fig. 4

Excavators Fig 4

MDC-71-105

Excavators

Fig -4



Fig. 5

Excavators Fig 5

MDC-71-106

Excavators

Fig -5

Excavators



Fig 6

Excavators Fig 6

MDC-71-107

Excavators

Fig -6



Fig. 0

Excavators Fig 0

MDC-71-108

Excavators



Fig. 1

Excavators Fig 1

MDC-71-109

Excavators

Fig -1



Fig. 2

Excavators Fig 2

MDC-71-110

Excavators

Fig -2



Fig. 3

Excavators Fig 3

MDC-71-111

Excavators

Fig -3



Fig. 4

Excavators Fig 4

MDC-71-112

Excavators

Fig -4

Excavators



Fig. 5

Excavators Fig 5

MDC-71-113

Excavators

Fig -5



Fig. 6

Excavators Fig 6

MDC-71-114

Excavators

Fig -6



Fig. 6

Excavators Fig 6

MDC-71-115

Excavators

Fig -6



Fig. 14

Excavators Fig 14

MDC-71-116

Excavators

Fig -14



Fig. 17

Excavators Fig 17

MDC-71-117

Excavators

Fig -17



Fig. 17W

Excavators Fig 17W

MDC-71-118

Excavators

Fig -17W

Excavators



Fig. 18

Excavators Fig 18

MDC-71-119

Excavators

Fig -18



Fig. 18W
Oval spoon

Oval Spoon Fig 18W

MDC-71-120

Excavators



Fig. 19

Excavators Fig 19

MDC-71-121

Excavators

Fig -19



Fig. 19W
Oval spoon

Oval Spoon Fig 19W

MDC-71-122

Excavators



Fig. 6

Excavators Fig 6

MDC-71-123

Excavators

Fig -6



Fig. 14

Excavators Fig 14

MDC-71-124

Excavators

Fig -14



Fig. 17

Excavators Fig 17

MDC-71-125

Excavators

Fig -17



Fig. 17W
Oval spoon

Oval Spoon Fig 17W

MDC-71-126

71-126



Fig. 18W
Oval spoon

Oval Spoon 18W

MDC-71-127

Excavators



Fig. 19

Excavators Fig 19

MDC-71-129

Excavators

Fig -19



Fig. 19W
Oval spoon

Oval Spoon Fig 19W

MDC-71-130

Excavators



Fig. 38/39

Excavators Fig 38/39

MDC-71-131

Excavators

Fig -38/39

Excavators



Fig. 63/64

Excavators Fig 63/64

MDC-71-133

Excavators

Fig 63/64



Fig. 65/66

Excavators Fig 65/66

MDC-71-134

Excavators



Fig. 31L

Excavators Fig 31L

MDC-71-135

Excavators

Fig -31L



Fig. 32L

Excavators Fig 32L

MDC-71-136

Excavators

Fig -32L



Cleoid / Discoid

MDC-71-137

No. 3/6 Excavator, double end



Cleoid / Discoid

MDC-71-138

No. 89/92 Carver - Discoid " Cleoid, octagonal handle

Scalers



Fig. U15
Towner

Towner Fig U15

MDC-72-104

Scalers

Fig -U15



Fig. U15/33
Towner Jaquette

Towner Jaquette Fig- U15/33

MDC-72-105

Scalers

Fig- U15/33



Fig. U15/30
Towner Jaquette

Towner Jaquette Fig- 15/30

MDC-72-106

Scalers

Fig- 15/30



Fig H5/33

Fig- H5/33

MDC-72-107

Scalers

Fig -H5/33



Fig. H6/H7

Fig- H6/H7

MDC-72-108

Scalers

Fig- H6/H7



Fig. 1/2

Fig- 1/2

MDC-72-109

Scalers

Fig -1/2

Scalers



Fig. U15/33
Towner-Jaquette

Towner Jaquette Fig- U15/33

MDC-72-110

Scalers

Fig- U15/33



Fig. J15/33
Towner-Jaquette

Towner Jaquette Fig- U15/30

MDC-72-111

Scalers

Fig- U15/30

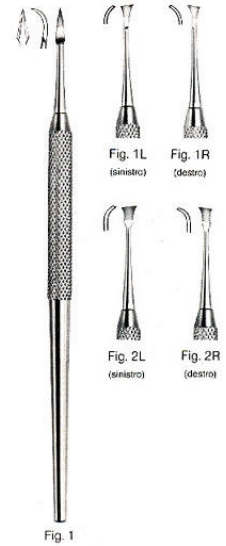

Fig. 1

Fig- 1

MDC-72-112

Scalers

Fig -1



Fig. 33

Scalers

MDC-72-117

Scalers

Fig -33 Fig -31 Fig -32 Fig -34 Fig -35



Fig. H5
Hygienist

Hygienist Fig- H5

MDC-72-122

Scalers

Fig -H5



P.K. THOMAS CARVERS FIG. 1
MDC-73-101
P.K.THOMAS WAX AND MODELLING
CARVERS FIG.1



P.K. THOMAS CARVERS FIG. 2
MDC-73-102
P.K.THOMAS WAX AND MODELLING
CARVERS FIG.2



P.K. THOMAS CARVERS FIG. 3
MDC-73-103
P.K.THOMAS WAX AND MODELLING
CARVERS FIG.3



P.K. THOMAS CARVERS FIG. 4
MDC-73-104
P.K.THOMAS WAX AND MODELLING
CARVERS FIG.4



P.K. THOMAS CARVERS FIG. 5
MDC-73-105
P.K.THOMAS WAX AND MODELLING
CARVERS FIG.5



P.K.THOMAS INSTRUMENTS
MDC-73-106
P.K.THOMAS WAX AND MODELLING
CARVERS FIG.5 SILVER



P.K.THOMAS INSTRUMENTS

MDC-73-107

P.K.THOMAS WAX AND MODELLING
CARVERS FIG.4 RED



P.K.THOMAS INSTRUMENTS

MDC-73-108

P.K.THOMAS WAX AND MODELLING
CARVERS FIG.3 BLUE



P.K.THOMAS INSTRUMENTS

MDC-73-109

P.K.THOMAS WAX AND MODELLING
CARVERS FIG.2 GOLD



P.K.THOMAS INSTRUMENTS

MDC-73-110

P.K.THOMAS WAX AND MODELLING
CARVERS FIG.1 GREEN



**FAHNENSTOCK Wax Carver 5 1/4" Knife,
5 1/4", Small**

MDC-73-111

FAHNENSTOCK Wax Carver 5 1/4" Knife, 5 1/4",
small



**FAHNENSTOCK Wax Carver 6 3/4" Knife,
6 3/4", Large**

MDC-73-112

FAHNENSTOCK Wax Carver 6 3/4" Knife, 6-
3/4", large



Impression Trays

MDC-74-101

Impression Trays

66x55mm



Impression Trays

MDC-74-102

Impression Trays

62x50mm



Impression Trays

MDC-74-103

Impression Trays

64x50mm



Impression Trays

MDC-74-104

Impression Trays

65x46mm



Impression Trays

MDC-74-105

Impression Trays

69x54mm



Impression Trays

MDC-74-106

Impression Trays

65x46mm



Impression Trays

MDC-74-107

Impression Trays

70x48mm



Impression Trays

MDC-74-108

Impression Trays

70x55mm



Impression Trays

MDC-74-109

Impression Trays

59x42mm



Impression Trays

MDC-74-110

Impression Trays

55x37mm



Impression Trays

MDC-74-111

Impression Trays

61x42mm



Impression Trays

MDC-74-112

Impression Trays

44mm

Impression Trays



Impression Trays

MDC-74-113

Impression Trays

44mm



Impression Trays

MDC-74-114

Impression Trays

44mm



Impression Trays

MDC-74-115

Impression Trays

66x55mm



Impression Trays

MDC-74-116

Impression Trays

65x46mm



Impression Trays

MDC-74-117

Impression Trays

69x54mm



Impression Trays

MDC-74-118

Impression Trays

69x54mm

Impression Trays



Impression Trays

MDC-74-119

Impression Trays

70x48mm



Impression Trays

MDC-74-120

Impression Trays

70x55mm



Impression Trays

MDC-74-121

Impression Trays

55x37mm



Impression Trays

MDC-74-122

Impression Trays

61x42mm



Impression Trays

MDC-74-123

Impression Trays

61x42mm



Impression Trays

MDC-74-124

Impression Trays

61x42mm



Impression Trays

MDC-74-125

Impression Trays



Dental Syringes

MDC-75-101

Dental Syringes

55x37mm



Dental Syringes

MDC-75-102

Dental Syringes

55x37mm



Self Aspiring 1.8cc

MDC-75-103

Dental Syringes

55x37mm



Cylinder Cartridge Syringe

MDC-75-104

Dental Syringes

55x37mm



Dental Syringes

MDC-75-106

Dental Syringes

55x37mm



Dental Syringes

MDC-75-107

Dental Syringes

55x37mm

Dental Syringes



C-W 1.8cc

MDC-75-108

Dental Syringes

55x37mm



Dental Syringes

MDC-75-109

Dental Syringes

55x37mm



Dental Syringes

MDC-75-110

Dental Syringes

55x37mm



Dental Syringes

MDC-75-111

Dental Syringes

55x37mm



Dental Syringes

MDC-75-112

Dental Syringes

55x37mm



Dental Syringes

MDC-75-113

Dental Syringes

55x37mm

Dental Syringes



Dental Syringes

MDC-75-118

Dental Syringes

Fig -1Fig -2Fig -4Fig -3



Dental Syringes

MDC-75-119

Aspira-Plus

1.8 ml



Dental Syringes

MDC-75-120

Dental Syringes

1.8 ml



Dental Syringes

MDC-75-122

Dental Syringes

1.8 ml



Dental Syringes

MDC-75-124

Dental Syringes

1.8 ml



Dental Syringes

MDC-75-126

Dental Syringes

18 ml

Dental Syringes



Dental Syringes

MDC-75-127
Dental Syringes
18 ml



Dental Syringe

MDC-75-128
Aspira-Plus
1.8 ml



Dental Syringe

MDC-75-129
Dental Syringe



Dental Syringe

MDC-
Dental Syringe



Dental Syringe

MDC-75-131
Dental Syringe



Dental Syringe

MDC-75-132
Dental Syringe
1 ml

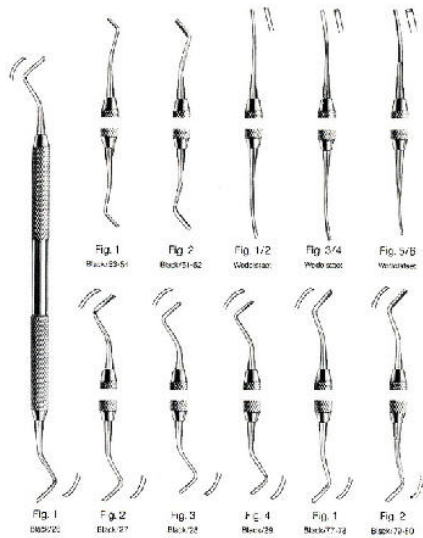

Wedeistaet

MDC-76-101

Cavity Preparation

Fig -1 Fig -2 Fig -4 Fig -5 Fig -6 Fig -3

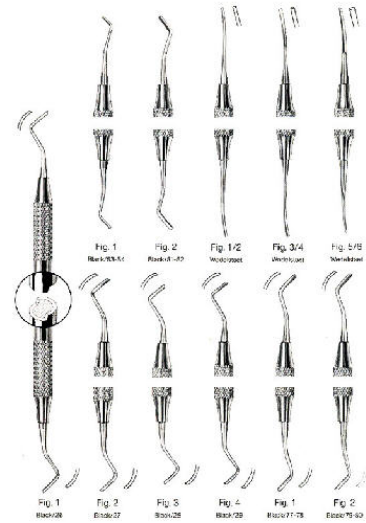

Wedeistaet

MDC-76-112

Cavity Preparation

Fig -1 Fig -2 Fig -4 Fig -5 Fig -6 Fig -3



11 Briault D/E Explorer
MDC-77-101

FIG. # 11 BRIAULT D/E EXPLORER. MADE OF SOLID STAINLESS STEEL HANDLE



11/12 Odu D/E Explorer
MDC-77-102

FIG. # 11/12 OLD DOMINION UNIVERSITY D/E EXPLORER. MADE OF SOLID STAINLESS STEEL HANDLE



11/12 Odu D/E After Five Explorer
MDC-77-103

FIG. # 11/12 ODU D/E AFTER FIVE EXPLORER. MADE OF SOLID STAINLESS STEEL HANDLE



2A Pigtail D/E Explorer
MDC-77-104

FIG. # 2A PIGTAIL D/E EXPLORER. MADE OF SOLID STAINLESS STEEL HANDLE



2H D/E Explorer
MDC-77-105

FIG. # 2H DE EXPLORER. MADE OF SOLID STAINLESS STEEL HANDLE



2R/2L D/E Explorer
MDC-77-106

FIG. # 2R/2L D/E EXPLORER. MADE OF SOLID STAINLESS STEEL HANDLE



3 Pigtail D/E Explorer

MDC-77-107

FIG. # 3 PIGTAIL D/E EXPLORER. MADE OF SOLID STAINLESS STEEL HANDLE



3CH Cowhorn D/E Explorer

MDC-77-108

FIG. # 3CH COWHORN D/E EXPLORER. MADE OF SOLID STAINLESS STEEL HANDLE



3ES D/E Explorer

MDC-77-109

FIG. # 3ES DE EXPLORER. MADE OF SOLID STAINLESS STEEL HANDLE



5 D/E Explorer

MDC-77-110

FIG. # 5 D/E EXPLORER. MADE OF SOLID STAINLESS STEEL HANDLE



6/3 D/E Explorer

MDC-77-111

FIG. # 6/3 DE EXPLORER. MADE OF SOLID STAINLESS STEEL HANDLE



17 S/E Explorer

MDC-77-112

FIG. # 17 SE EXPLORER. MADE OF SOLID STAINLESS STEEL HANDLE



23 Shepherd's Hook Explorer

MDC-77-113

FIG. # 23 SHEPHERD'S HOOK S/E
EXPLORER. MADE OF SOLID STAINLESS
STEEL HANDLE



3 S/E Explorer

MDC-77-114

FIG. # 3 SE EXPLORER. MADE OF SOLID
STAINLESS STEEL HANDLE



3A S/E Explorer

MDC-77-115

FIG. # 3A S/E EXPLORER. MADE OF SOLID
STAINLESS STEEL HANDLE



54 S/E Explorer

MDC-77-116

FIG. # 54 S/E EXPLORER. MADE OF SOLID
STAINLESS STEEL HANDLE



A Tips For MORREL Crown Remover

MDC-78-101

A tips for MORREL Crown Remover



Tips For MORREL Crown Remover

MDC-78-102

tips for MORREL Crown Remover



C Tips For MORREL Crown Remover

MDC-78-103

C tips for MORREL Crown Remover



MORREL Crown Remover, With 3 Points

MDC-78-104

MORREL Crown Remover, with 3 points



WYNMAN Carbide Crown Gripper, 5-1/2", Without Ratchet, With TC Jaws

MDC-78-105

WYNMAN Carbide Crown Gripper, 5-1/2",
without ratchet, with TC jaws



X-Ray Film Hangers 6 Clips

MDC-79-101

X-RAY FILM HANGERS 6 CLIPS MADE OF STAINLESS STEEL



X-Ray Film Hangers 10 Clips

MDC-79-102

X-RAY FILM HANGERS 10 CLIPS MADE OF STAINLESS STEEL

Matrix Retainers



Matrix Retainer Toffilemire

MDC-80-101

MATRIX BAND RETAINER TOFFILEMIRE.
AVAILABLE IN STRAIGHT & CONTRA.
STAINLESS STEEL



**Toffilemire Matrix Retainer Junior /
Child**

MDC-80-102

MATRIX BAND RETAINER TOFFILEMIRE
JUNIOR / CHILD. AVAILABLE IN STRAIGHT &
CONT



**Toffilemire Matrix Retainer Senior /
Adult**

MDC-80-103

MATRIX BAND RETAINER TOFFILEMIRE
SENIOR / CHILD. AVAILABLE IN STRAIGHT &
CONT



Toffilemire Matrix Retainer Universal

MDC-80-104

MATRIX BAND RETAINER TOFFILEMIRE
UNIVERSAL. AVAILABLE IN STRAIGHT &
CONTRA. STAINLESS STEEL



Matrix Band Retainer Ivory 8

MDC-80-105

MATRIX BAND RETAINER IVORY 8,
AVAILABLE IN 5MM, 6MM, 7MM. STAINLESS
STEEL



Matrix Band Retainer Ivory Plain

MDC-80-106

MATRIX RETAINER IVORY PLAIN / WITHOUT
LATERAL SHIELD (JAW). STAINLESS STEEL





Matrix Retainer Ivory With Shield

MDC-80-107

MATRIX RETAINER IVORY WITH LATERAL SHIELD (JAW). STAINLESS STEEL



Matrix Retainer Cheek Protector

MDC-80-108

MATRIX BAND RETAINER CHEEK PROTECTOR. STAINLESS STEEL



Matrix Band Retainer Nystrom Left

MDC-80-109

MATRIX BAND RETAINER NYSTROM LEFT. STAINLESS STEEL



Matrix Band Retainer Nystrom Right

MDC-80-110

MATRIX BAND RETAINER NYSTROM RIGHT. STAINLESS STEEL



Matrix Band Retainer Siqveland (Ash Narrow)

MDC-80-111

MATRIX BAND RETAINER SIQVELAND (ASH NARROW). STAINLESS STEEL



Matrix Band Retainer Siqveland (Ash Wide)

MDC-80-112

MATRIX BAND RETAINER SIQVELAND (ASH WIDE). STAINLESS STEEL

Matrix Retainers



Matrix Band Retainer Ivory Didner (Adjustable)

MDC-80-113

MATRIX BAND RETAINER IVORY DIDNER (ADJUSTABLE)



Matrix Retainer Ivory Separator

MDC-80-114

MATRIX BAND RETAINER IVORY SEPARATOR. STAINLESS STEEL



Matrix Retainer Elliott Separator

MDC-80-115

MATRIX BAND RETAINER ELLIOTE SEPARATOR. STAINLESS STEEL



Matrix Retainer Ivory 8 N

MDC-80-116

MATRIX BAND RETAINER IVORY 8N. MADE OF STAINLESS STEEL



Matrix Retainer Didner 8 P

MDC-80-117

MATRIX BAND RETAINER IVORY 8P. MADE OF STAINLESS STEEL

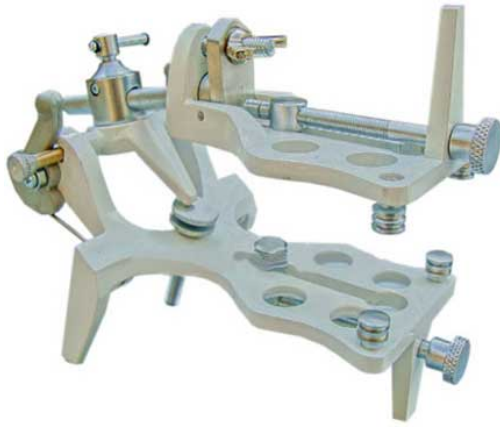

**PLASTERLESS ARTICULATOR
GALETTI (WHITE)**

MDC-81-101

HIGH TECH PLASTERLESS ARTICULATOR
GALETTI WITH ADJUSTABLE SCREWS AT
REARS & F



Vibratory Polished Articulator Galetti

MDC-81-102

GALETTI ARTICULATOR IS SOLIDLY
CONSTRUCTED OF METAL ALLOY CASTING.
EASY TO US



ANATOMICAL ARTICULATOR (ASA)

MDC-81-103

ANATOMICAL ARTICULATOR WITH BEARING
ROD & INCISIVE PIN, 4 MOUNTING PLATES &
S



UNIVERSAL ARTICULATOR

MDC-81-104

ANATOMICAL ARTICULATOR, MADE OF
ALUMINUM PRESSOFUSION OF ONLY
590/GR OF WEIGH



Gnatus Pro JP30 Articulator

MDC-81-105

The Gnatus Pro JP30 Articulator offers the best
performance with an excellent



ANATOMICAL ARTICULATOR

MDC-81-106

ANATOMICAL ARTICULATOR WITH INCISIVE
PIN, 4 MOUNTING PLATES AND
SUPPORTING BA

Articulators



**KEYSTONE BLACK ARTICULATOR
WIRED**

MDC-81-107

KEYSTONE DELUXE UNIVERSAL TYPE-A
ARTICULATOR. INTERCHANGEABLE,
INCISAL PIN IN



**KEYSTONE DELUXE MAGNET
ARTICULATOR**

MDC-81-108

KEYSTONE DELUXE MAGNETIC DENTURE
ARTICULATOR WITH PLATES,
INTERCHANGEABLE, IN

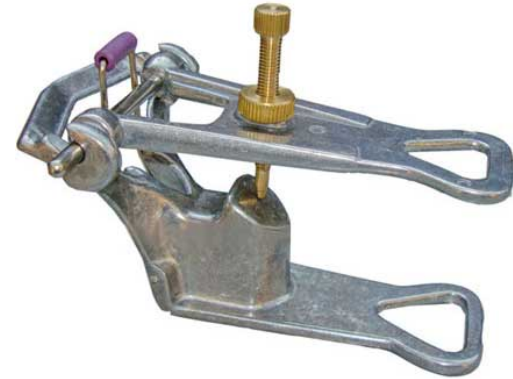

**PROFESSIONAL OCCULUSOR
ARTICULATOR**

MDC-81-109

PROFESSIONAL OCCLUSOR, VIBRATORY
POLISHED ARTICULATOR - ALUMINUM,
BRASS, STAINLESS STEEL



Magicart-1 Articulator

MDC-81-110

LIGHTWEIGHT, HIGH-QUALITY MAGIC ART
ARTICULATOR SECURELY HOLDS
QUADRANT MODEL



**FULL DENTURE ARTICULATOR
(ROUND)**

MDC-81-111

FULL DENTURE CHROME PLATED
ARTICULATOR (3 SLOT ROUND)

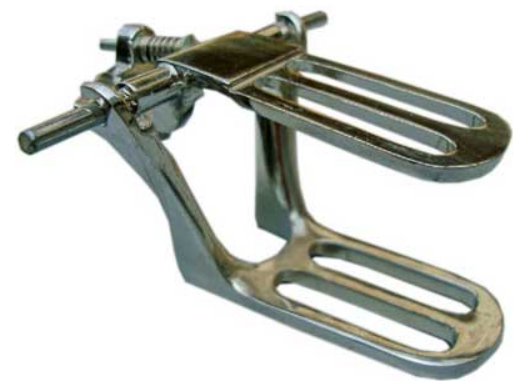

**MODEL 'M' HI TOP STEPHAN
ARTICULATOR**

MDC-81-112

FULL DENTURE CHROMIUM PLATED
ARTICULATOR. PROVIDES ADDITIONAL
VERTICAL DIMENS

Articulators



Chromium Plated Plain Round

MDC-81-113

Nickle Chromium Plated Plain Round Articulator



UNIVERSAL ARTICULATOR (YELLOW)

MDC-81-114

UNIVERSAL ARTICULATOR OPENING 125
WITH 4 MOUNTING PLATES - CONDYLAR
INLINATI



FOSTER DENTURE ARTICULATOR

MDC-81-115

THIS ARTICULATOR IS EQUIPPED WITH AN
ADJUSTABLE ANTERIOR PIN STOP &
POSTERIOR



**FORK CHROME PLATED
ARTICULATOR**

MDC-81-116

NICKLE CHROMIUM PLATED ARTICULATOR
FORK PATTERN



HINGE ARTICULATOR FULL ARCH

MDC-81-117

AN ECONOMICAL & SIMPLE CHROMIUM
PLATED HINGE ARTICULATOR FOR
MOUNTING FULL AR



**QUADRANT / CROWNED BRIDGE
ARTICULATOR**

MDC-81-118

BRASS HINGE CROWNED BRIDGE
ARTICULATOR FOR MOUNTING QUADRANT
CASES. CROWN & B

Articulators



UNIVERSAL ARTICULATOR (BLUE)

MDC-81-119

UNIVERSAL ARTICULATOR OPENING 125◊ WITH 4 MOUNTING PLATES - CONDYLAR INLINATI



FOSTER / APEX # 2 ARTICULATOR

MDC-81-120

FOSTER / APEX # 2 ARTICULATOR, THE WIDTH AT THE JOINT IS 1-3/4◊ WITH A VERTIC



MORTIMER-I OCULADER ARTICULATOR

MDC-81-121

PLAINLINE BALL BEARING MORTIMER-I OCULADER ARTICULATOR. ALL FILLED WITH HIGH



MORTIMER-II OCULADER ARTICULATOR

MDC-81-122

PLAINLINE BALL BEARING MORTIMER-II OCULADER ARTICULATOR. ALL FILLED WITH HIGH



OCCLUSOR, WIRE ARTICULATOR

MDC-81-123

OCCLUSOR, WIRE ARTICULATOR - STAINLESS STEEL & ALUMINUM



ASA Articulator 5002

MDC-81-124

ASA ARTICULATOR WITH LATERAL MOMENT. MADE OF ALUMINUM DIE CASTING WITH 2 MOUN



Model "A" Crescent Stephan Articulator

MDC-81-125

CRESCENT STEPHAN MODEL **A** ARTICULATOR IS USED FOR PARTIALS, CENTER SPRING WI



Bite Fork / Occlusal Alignment Plane

MDC-81-126

BITE FORK IS A RELIABLE INSTRUMENT FOR CHECKING THE CORRECT POSITION OF THE M



Bandage And Utility Scissors

MDC-82-101

Bandage and Utility Scissors, 7-1/2" (19.1 cm),
needle destroyer, serrated b



Plaster And Compound Knife

MDC-82-102

Plaster and Compound Knife



Soldering Tweezers, Curved

MDC-82-103

Soldering Tweezers, curved



SWISS Jeweler Style Forceps

MDC-82-104

SWISS Jeweler style Forceps, non-magnetic
stainless steel, style 3, narrow, f



SWISS Jeweler Style Forceps

MDC-82-105

SWISS Jeweler style Forceps, non-magnetic
stainless steel, style 5, Super fin



SWISS Jeweler Style Forceps

MDC-82-106

SWISS Jeweler style Forceps, non-magnetic
stainless steel, style 7, fine, cur



Calipers

MDC-82-107

Calipers



Calipers

MDC-82-108

Calipers



Steel Ruler

MDC-82-109

Steel Ruler



Forceps For Articulation Paper

MDC-82-110

Forceps for articulation paper



+92 (334) 8676677



info@mmdentalcorp.com



Sialkot, Punjab, Pakistan

